

NELUX ARCHITECTURAL LIGHTING PRODUCTS

NELUX ARCHITECTURAL LIGHTING

# CATALOG 2022



# OUTDOOR LIGHTING II

**LED UNDERGROUND LIGHT PAGE 1 TO PAGE 18**

**LED GARDEN SPIKE LIGHT PAGE 19 TO PAGE 21**

**LED UNDERWATER LIGHT PAGE 22 TO PAGE 26**

**OUTDOOR LED STEP LIGHT PAGE 27 TO PAGE 31**

**OUTDOOR LED WALL LIGHT PAGE 32 TO PAGE 53**

**LED LAWN LIGHT PAGE 54 TO PAGE 56**

**LED BOLLARD LIGHT PAGE 57**

**LED INDOOR STEP LIGHT PAGE 58 TO PAGE 62**

# 01

LED Underground Light

● 6000K ● 5000K ● 4000K ● 3000K ● 2700K

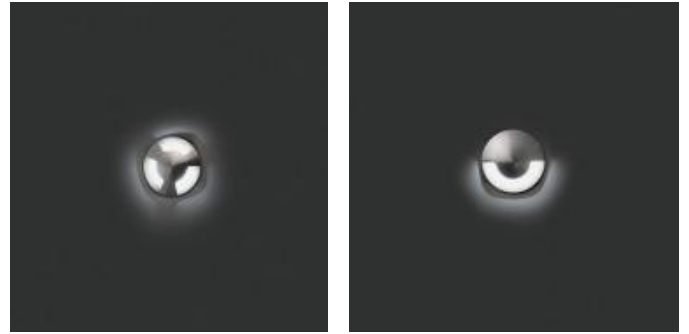

**3W COB underground light**

| Parameter                |   |
|--------------------------|---|
| <b>General Data</b>      |   |
| Name:                    | LED 3W Stainless Steel Underground Light/Floor Light                                    |
| Item No.                 | SUS04   |
| Power                    | 3W  |
| LED type                 | CREE/Brigelux/Osram   |
| Luminous flux            | 80lm/W  |
| CCT                      | 2700K, 3000K, 4000K, 6000K, R/G/Y/B   |
| CRI                      | 80+   |
| Beam angle               | 40°   |
| Dimension                | Ø92mm   |
| Cut out                  | φ82x90mm  |
| Warranty                 | 3 Years   |
| Certifications           | CE, RoHS  |
| <b>Electrical Data</b>   |   |
| Input voltage            | 90-265V AC or DC12, DC24V   |
| Insulation class         | Class I, Class III  |
| Cable                    | 1PC rubber cable 1M H05RN-F 3x1.0mm square, 1PC rubber cable 1M H05RN-F 2x1.0mm square, |
| Driver                   | Eaglerise   |
| <b>Construction Data</b> |   |
| IP rating                | IP67 Waterproof   |
| IK rating                | IK08  |
| Housing                  | SUS304/316  |
| Protection finishing     | SUS   |
| Trim                     | SUS304/316  |
| Glass                    | Step tempered Glass. T=8mm.   |
| Loading capacity         | 500 kgs   |
| Cable Gland              | PG7 IP67  |
| Gasket                   | O-ring PMQ silicone seal  |
| <b>Accessories</b>       |   |
| Mounting Sleeve          | Anti-corrosion PVC. Black   |



**Dimenssion**

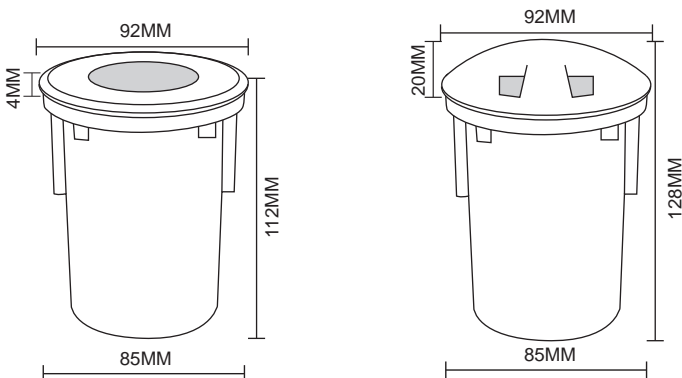

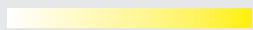

● 6000K ● 5000K ● 4000K ● 3000K ● 2700K

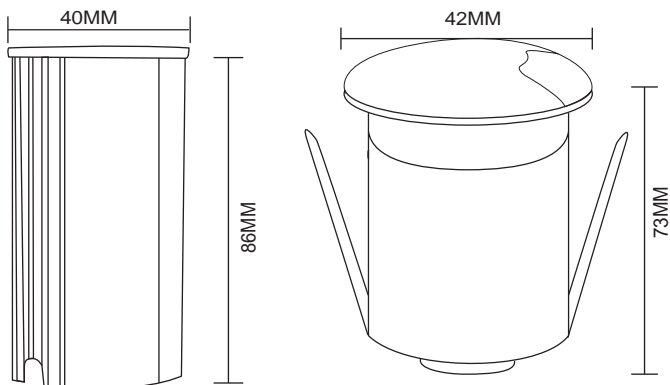

| Parameter                |  |            |                  |              |
|--------------------------|--|------------|------------------|--------------|
| <b>General Data</b>      |  |            |                  |              |
| Name:                    | LED 1W Stainless Steel Underground Light/Floor Light                                       |            |                  |              |
| Item No.                 | SUS01,SUS02,SUS03  |            |                  |              |
| Power                    | 1W   |            |                  |              |
| LED type                 | CREE/Brigelux/Osram  |            |                  |              |
| Luminous flux            | 80lm/W   |            |                  |              |
| CCT                      | 2700K, 3000K, 4000K, 6000K, R/G/Y/B  |            |                  |              |
| CRI                      | 80+  |            |                  |              |
| Beam angle               | 10°,15°, 30°, 45°, 60°, 90°, 120°  |            |                  |              |
| Dimension                | Please see table below   |            |                  |              |
| Cut out                  | Please see table below   |            |                  |              |
| Warranty                 | 3 Years  |            |                  |              |
| Certifications           | CE, RoHS   |            |                  |              |
| Power/Model              | Chip Brand   | Dimension  | Material         | Driver brand |
| 1W :SUS01W               | CREE/Brigelux/Osram  | Ø42x H73mm | SUS316 or SUS304 | Eaglerise    |
| 1W :SUS02W               | CREE/Brigelux/Osram  | Ø52 H80mm  | SUS316 or SUS304 | Eaglerise    |
| 1W :SUS03W               | CREE/Brigelux/Osram  | Ø62x H85mm | SUS316 or SUS304 | Eaglerise    |
| <b>Electrical Data</b>   |  |            |                  |              |
| Input voltage            | 90-265V AC or DC12, DC24V  |            |                  |              |
| Insulation class         | Class I, Class III   |            |                  |              |
| Cable                    | 1PC rubber cable 1M H05RN-F 3x1.0mm square,<br>1PC rubber cable 1M H05RN-F 2x1.0mm square, |            |                  |              |
| Driver                   | Eaglerise  |            |                  |              |
| <b>Construction Data</b> |  |            |                  |              |
| IP rating                | IP67 Waterproof  |            |                  |              |
| IK rating                | IK08   |            |                  |              |
| Housing                  | SUS304/316   |            |                  |              |
| Protection finishing     | SUS  |            |                  |              |
| Trim                     | SUS304/316   |            |                  |              |
| Glass                    | Step tempered Glass. T=8mm.  |            |                  |              |
| Loading capacity         | 500 kgs  |            |                  |              |
| Cable Gland              | PG7 IP67   |            |                  |              |
| Gasket                   | O-ring PMQ silicone seal   |            |                  |              |
| <b>Accessories</b>       |  |            |                  |              |
| Mounting Sleeve          | Anti-corrosion PVC. Black  |            |                  |              |
| Clip                     | With SUS304 spring that's for deck lights or ceiling lights application                    |            |                  |              |

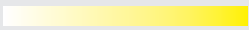

6000K 5000K 4000K 3000K 2700K



SUS316



Tempered Glass T:8mm



| Parameter                |   |
|--------------------------|---|
| <b>General Data</b>      |   |
| Name:                    | 1W LED Underground Light/ Deck Light/Step Light                                       |
| Item No.                 | DMS1W   |
| Power                    | 1W  |
| LED type                 | CREE XBD  |
| Luminous flux            | 80lm  |
| CCT                      | 2700K, 3000K, 4000K, 6000K, R/G/Y/B   |
| CRI                      | 80+   |
| Beam angle               | 16°, 25°, 40°, 60°  |
| Dimension                | Ø42x53 (mm) Diameter x length   |
| Cut out                  | With Mounting Sleeve: Ø80x95 (mm) Diameter x length<br>Without Mounting Sleeve :Ø33mm |
| Warranty                 | 3 Years   |
| Certifications           | CE, RoHS  |
| <b>Electrical Data</b>   |   |
| Input voltage            | DC12-24V  |
| Insulation class         | Class III   |
| Cable                    | 1PC rubber cable 1M H05RN-F 2x0.5mm square  |
| Driver                   | Done  |
| <b>Construction Data</b> |   |
| IP rating                | IP67 Waterproof   |
| IK rating                | IK08  |
| Housing                  | Solid Passivated (Anodizing) Aluminum CNC machined                                    |
| Protection finishing     | 20~25µm thickness anodized film for housing.  |
| Trim                     | SUS316  |
| Glass                    | Step tempered Glass. T=8mm.   |
| Loading capacity         | 500 kgs   |
| Cable Gland              | PG7 IP67  |
| Gasket                   | O-ring PMQ silicone seal  |
| <b>Accessories</b>       |   |
| Mounting Sleeve          | Anti-corrosion PVC. Black   |
| Clip                     | With SUS304 spring that's for deck lights or ceiling lights application               |

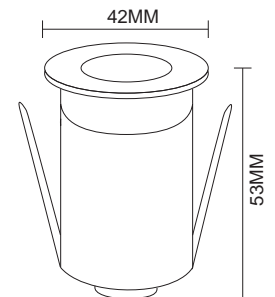
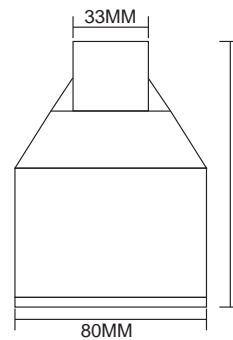

Luminous Intensity Distribution Curve

Illuminance at a Distance

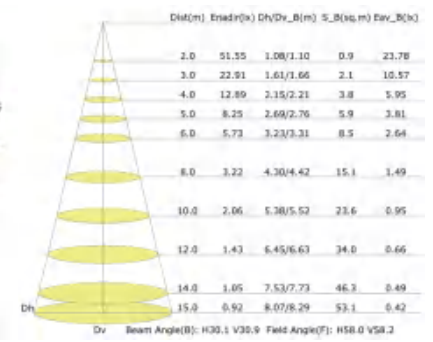
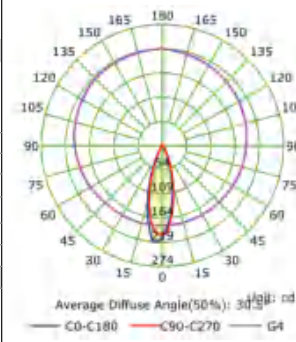

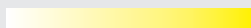

6000K 5000K 4000K 3000K 2700K



| Parameter            |   |
|----------------------|---|
| General Data         |   |
| Name:                | 3W LED Underground Light/ Deck Light/Step Light                         |
| Item No.             | DMM3W COB   |
| Power                | 3W  |
| LED type             | CREE XBD, Bridgelux COB   |
| Luminous flux        | 80lm/W  |
| CCT                  | 2700K, 3000K, 4000K, 6000K, R/G/Y/B                                     |
| CRI                  | 80+   |
| Beam angle           | 40°   |
| Dimension            | Ø46x72 (mm) Diameter x length   |
| Cut out              | With Mounting Sleeve: Ø80x95 (mm) Diameter x Length                     |
| Warranty             | 3 Years   |
| Certifications       | CE, RoHS  |
| Electrical Data      |   |
| Input voltage        | DC12-24V  |
| Insulation class     | Class III   |
| Cable                | 1PC rubber cable 1M H05RN-F 2x0.5mm square                              |
| Driver               | Done  |
| Construction Data    |   |
| IP rating            | IP67 Waterproof   |
| IK rating            | IK08  |
| Housing              | Solid Passivated (Anodizing) Aluminum CNC machined                      |
| Protection finishing | 20~25µm thickness anodized film for housing.                            |
| Trim                 | SUS316  |
| Glass                | Step tempered Glass. T=8mm.   |
| Loading capacity     | 500 kgs   |
| Cable Gland          | PG7 IP67  |
| Gasket               | O-ring PMQ silicone seal  |
| Accessories          |   |
| Mounting Sleeve      | Anti-corrosion PVC. Black   |
| Clip                 | With SUS304 spring that's for deck lights or ceiling lights application |

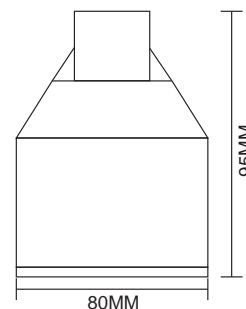
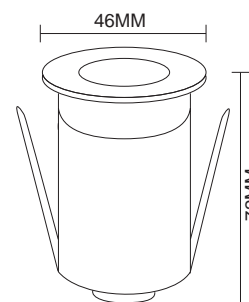

● 6000K ● 5000K ● 4000K ● 3000K ● 2700K

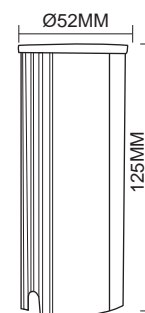
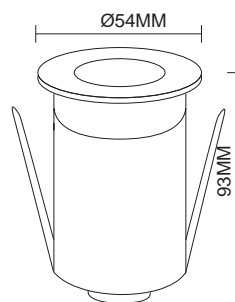

| Parameter                |   |
|--------------------------|---|
| <b>General Data</b>      |   |
| Name:                    | 3W/5W LED COB Underground Light/ Deck Light/Step Light                  |
| Item No.                 | DML3W,DML5W,  |
| Power                    | 3W/5W   |
| LED type                 | CREE XBD  |
| Luminous flux            | 80lm/W  |
| CCT                      | 2700K, 3000K, 4000K, 6000K, R/G/Y/B                                     |
| CRI                      | 80+   |
| Beam angle               | 40°   |
| Dimension                | Ø54x93 (mm) Diameter x length   |
| Cut out                  | With Mounting Sleeve: Ø52x125 (mm) Diameter x length                    |
| Warranty                 | 3 Years   |
| Certifications           | CE, RoHS  |
| <b>Electrical Data</b>   |   |
| Input voltage            | DC12-24V  |
| Insulation class         | Class III   |
| Cable                    | 1PC rubber cable 1M H05RN-F 2x0.5mm square                              |
| Driver                   | /   |
| <b>Construction Data</b> |   |
| IP rating                | IP67 Waterproof   |
| IK rating                | IK08  |
| Housing                  | Solid Passivated (Anodizing) Aluminum CNC machined                      |
| Protection finishing     | 20~25µm thickness anodized film for housing.                            |
| Trim                     | Aluminum 6063   |
| Glass                    | Step tempered Glass. T=8mm.   |
| Loading capacity         | 500 kgs   |
| Cable Gland              | PG7 IP67  |
| Gasket                   | O-ring PMQ silicone seal  |
| <b>Accessories</b>       |   |
| Mounting Sleeve          | Anti-corrosion PVC. Black   |
| Clip                     | With SUS304 spring that's for deck lights or ceiling lights application |



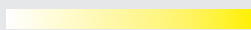

6000K 5000K 4000K 3000K 2700K

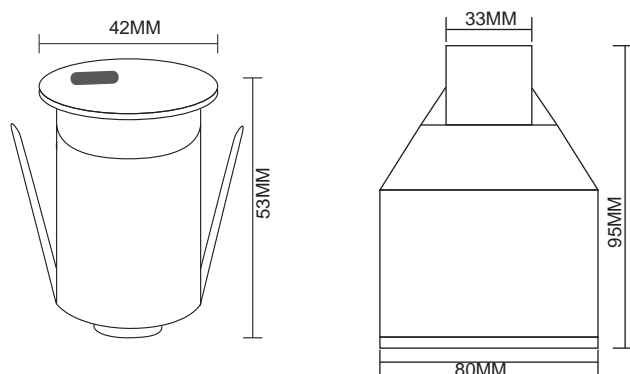
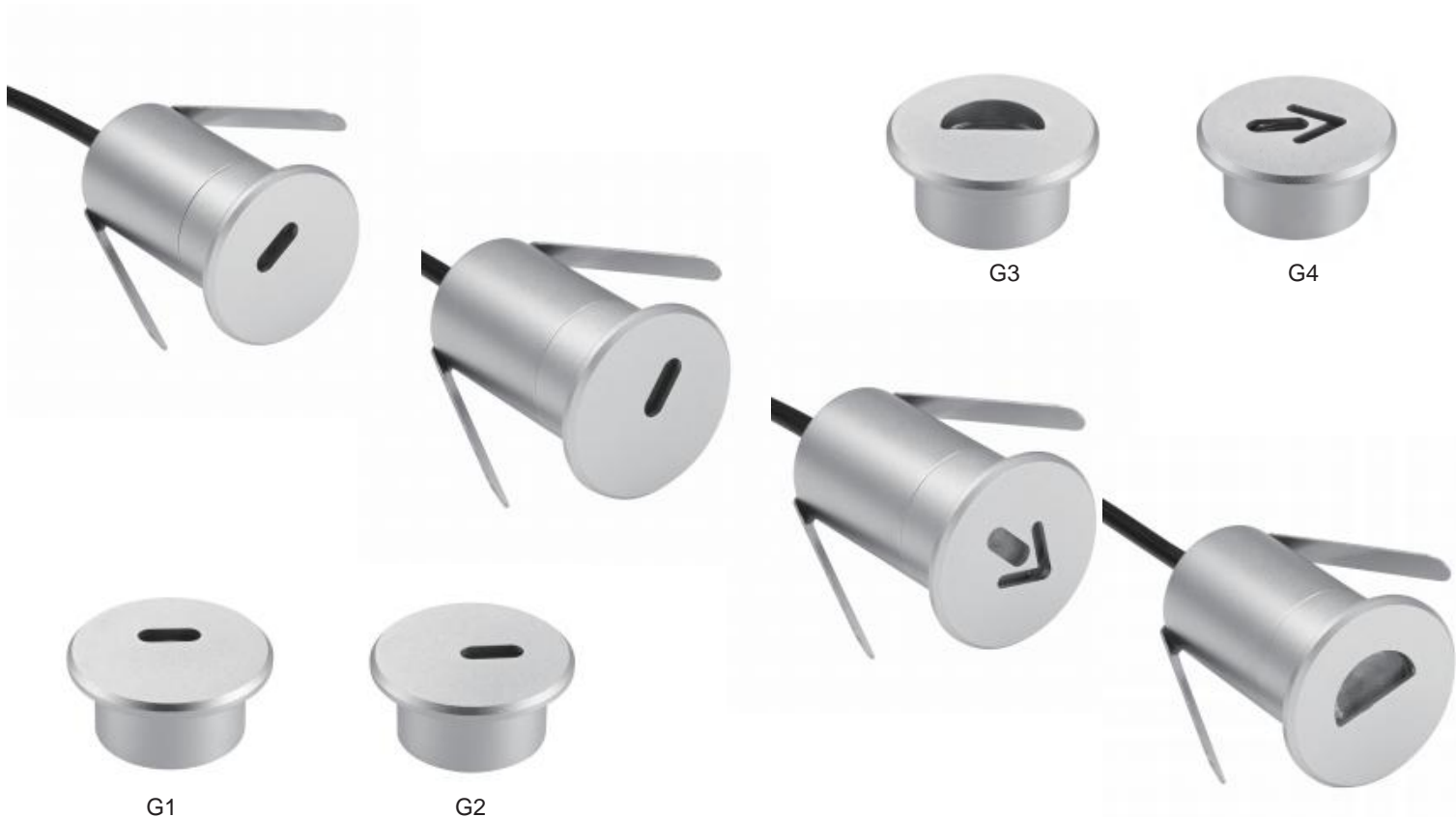

|   |                      |   |
|---|----------------------|---|
| Parameter                                 |                      |   |
| General Data                              | Cable                | 1PC rubber cable 1M H05RN-F 2x0.5mm square                              |
| Name: 1W LED Underground                  | Driver               | /   |
| Light/ Deck Light/Step Light              | Construction Data    |   |
| Item No. TJD1W                            | IP rating            | IP67 Waterproof   |
| Power 1W                                  | IK rating            | IK08  |
| LED type CREE XBD                         | Housing              | Solid Passivated (Anodizing) Aluminum CNC machined                      |
| Luminous flux 80lm                        | Protection finishing | 20~25µm thickness anodized film for housing.                            |
| CCT 2700K, 3000K, 4000K, 6000K, R/G/Y/B   | Trim                 | Aluminum 6063   |
| CRI 80+                                   | Glass                | Step tempered Glass. T=8mm.   |
| Beam angle G1, G2, G3,G4                  | Loading capacity     | 500 kgs   |
| Dimension Ø42x53 (mm) Diameter x length   | Cable Gland          | PG7 IP67  |
| Cut out With Mounting Sleeve: Ø80x95 (mm) | Gasket               | O-ring PMQ silicone seal  |
| Without Mounting Sleeve :Ø33mm            | Accessories          |   |
| Net weight                                | Mounting Sleeve      | Anti-corrosion PVC. Black   |
| Warranty 3 Years                          | Clip                 | With SUS304 spring that's for deck lights or ceiling lights application |
| Certifications CE, RoHS                   |                      |   |
| Electrical Data                           |                      |   |
| Input voltage DC12-24V                    |                      |   |
| Insulation class Class III                |                      |   |

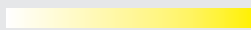

6000K 5000K 4000K 3000K 2700K



| Parameter                |   |
|--------------------------|---|
| <b>General Data</b>      |   |
| Name:                    | 3W LED Underground Light/ Deck Light/Step Light                         |
| Item No.                 | DMC3W   |
| Power                    | 3W  |
| LED type                 | CREE XBD, Bridgelux COB   |
| Luminous flux            | 80lm/W  |
| CCT                      | 2700K, 3000K, 4000K, 6000K, R/G/Y/B                                     |
| CRI                      | 80+   |
| Beam angle               | B1, B2, B3  |
| Dimension                | Ø46x72 (mm) Diameter x length   |
| Cut out                  | With Mounting Sleeve: Ø80x95 (mm) Diameter x length                     |
| Warranty                 | 3 Years   |
| Certifications           | CE, RoHS  |
| <b>Electrical Data</b>   |   |
| Input voltage            | DC12-24V  |
| Insulation class         | Class III   |
| Cable                    | 1PC rubber cable 1M H05RN-F 2x0.75mm square                             |
| Driver                   | /   |
| <b>Construction Data</b> |   |
| IP rating                | IP67 Waterproof   |
| IK rating                | IK08  |
| Housing                  | Solid Passivated (Anodizing) Aluminum CNC machined                      |
| Protection finishing     | 20~25µm thickness anodized film for housing.                            |
| Trim                     | Aluminum 6063   |
| Glass                    | Step tempered Glass. T=8mm.   |
| Loading capacity         | 500 kgs   |
| Cable Gland              | PG7 IP67  |
| Gasket                   | O-ring PMQ silicone seal  |
| <b>Accessories</b>       |   |
| Mounting Sleeve          | Anti-corrosion PVC. Black   |
| Clip                     | With SUS304 spring that's for deck lights or ceiling lights application |

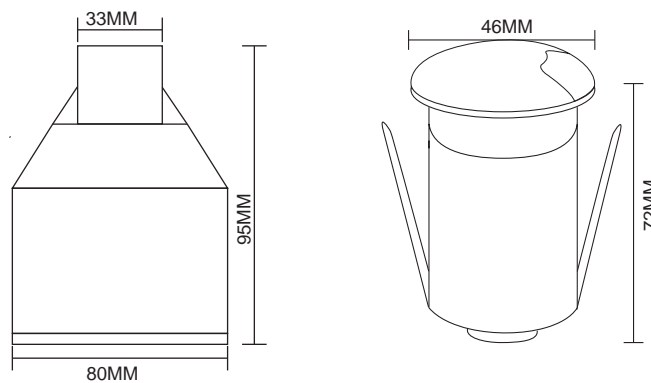

● 6000K ● 5000K ● 4000K ● 3000K ● 2700K

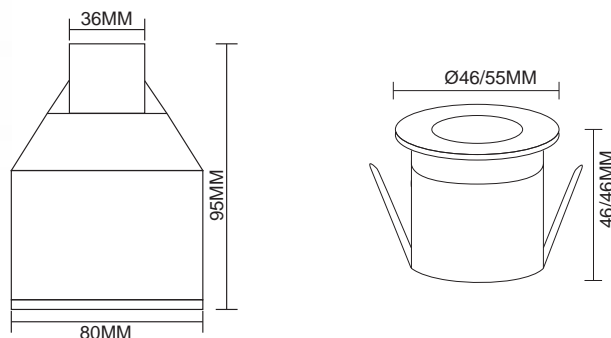

| Parameter                |   |
|--------------------------|---|
| <b>General Data</b>      |   |
| Name:                    | 1W/ 3W LED Underground Light/ Deck Light/Step Light                                   |
| Item No.                 | DKS 1W 3W   |
| Power                    | 1W/3W   |
| LED type                 | CREE XBD  |
| Luminous flux            | 80lm/W  |
| CCT                      | 2700K, 3000K, 4000K, 6000K, R/G/Y/B   |
| CRI                      | 80+   |
| Beam angle               | 60°   |
| Dimension                | 1W: Ø46x46 (mm), 3W: Ø55x46 (mm) Diameter x length                                    |
| Cut out                  | With Mounting Sleeve: Ø80x95 (mm) Diameter x length<br>Without Mounting Sleeve :Ø36mm |
| Warranty                 | 3 Years   |
| Certifications           | CE, RoHS  |
| <b>Electrical Data</b>   |   |
| Input voltage            | DC12-24V  |
| Insulation class         | Class III   |
| Cable                    | 1PC rubber cable 1M H05RN-F 2x0.5mm square  |
| Driver                   | /   |
| <b>Construction Data</b> |   |
| IP rating                | IP67 Waterproof   |
| IK rating                | IK08  |
| Housing                  | Solid Passivated (Anodizing) Aluminum CNC machined                                    |
| Protection finishing     | 20~25µm thickness anodized film for housing.  |
| Trim                     | SUS316  |
| Glass                    | Step tempered Glass. T=8mm.   |
| Loading capacity         | 500 kgs   |
| Cable Gland              | PG7 IP67  |
| Gasket                   | O-ring PMQ silicone seal  |
| <b>Accessories</b>       |   |
| Mounting Sleeve          | Anti-corrosion PVC. Black   |
| Clip                     | With SUS304 spring that's for deck lights or ceiling lights application               |

● 6000K ● 5000K ● 4000K ● 3000K ● 2700K

max. 50W  
GU10

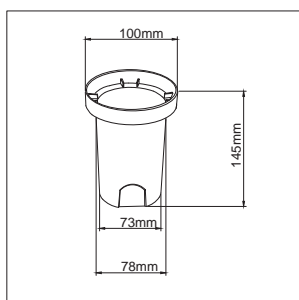
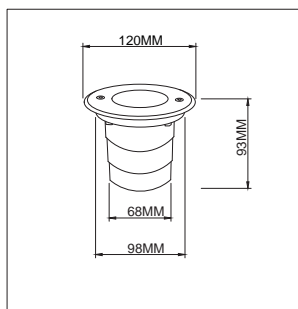
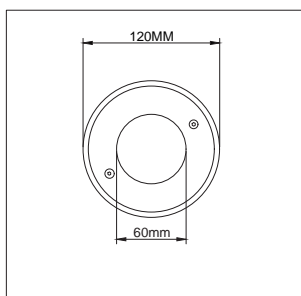
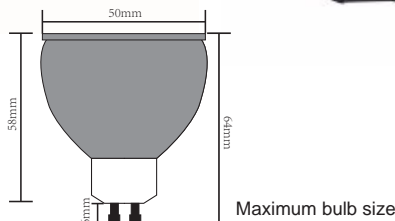

|                          |   |
|--------------------------|---|
| <b>General Data</b>      |   |
| Name:                    | GU10 Underground Light                      |
| Item No.                 | HT-GU10                                     |
| Power                    | Max 50W                                     |
| Base type                | GU10  |
| Dimension                | Ø120x135 (mm) Diameter x length             |
| Cut out                  | Ø100x145 (mm) Diameter x length             |
| <b>Net weight</b>        |   |
| Warranty                 | 3 Years                                     |
| Certifications           | CE, RoHS                                    |
| <b>Electrical Data</b>   |   |
| Input voltage            | 90-265V AC                                  |
| Insulation class         | Class I                                     |
| Cable                    | 1PC rubber cable 1M H05RN-F 3x0.75mm square |
| Driver                   | /   |
| <b>Construction Data</b> |   |
| IP rating                | IP67 Waterproof                             |
| IK rating                | IK09  |
| Housing                  | Die casting ADC #12 Aluminum                |
| Protection finishing     | Anti-corrosion coating 90~100µm thickness   |
| Trim                     | Stainless steel 316                         |
| Glass                    | Step tempered Glass. T=8mm.                 |
| Loading capacity         | 500 kgs                                     |
| Cable Gland              | PG7 IP67                                    |
| Gasket                   | O-ring PMQ silicone seal                    |
| <b>Accessories</b>       |   |
| Mounting Sleeve          | Anti-corrosion PVC. Black                   |

6000K 5000K 4000K 3000K 2700K

max. 50W  
GU10

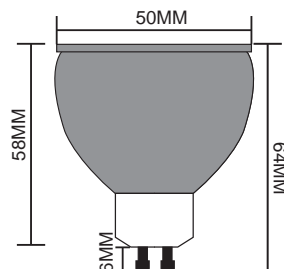
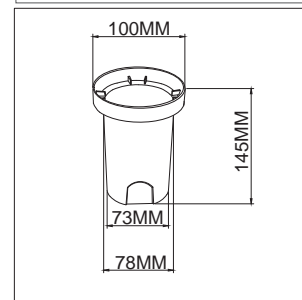
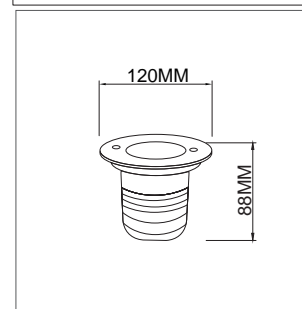
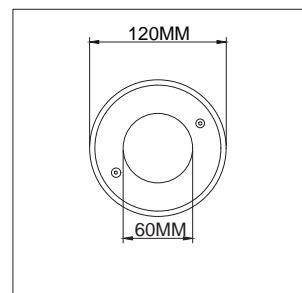

Maximum bulb size



| General Data     |   | Construction Data    |  |
|------------------|---|----------------------|--|
| Name:            | GU10 Underground Light                      | IP rating            | IP67 Waterproof  |
| Item No.         | HT-GU10                                     | IK rating            | IK08   |
| Power            | Max 50W                                     | Housing              | Solid Passivated (Anodizing) Aluminum CNC machined     |
| Base type        | GU10  | Protection finishing | 20~25µm thickness anodized film for housing. Dark grey |
| Luminous flux    | /   | Trim                 | SUS316   |
| CCT              | /   | Glass                | Step tempered Glass. T=8mm.                            |
| CRI              | /   | Loading capacity     | 500 kgs  |
| Beam angle       | /   | Cable Gland          | PG7 IP67   |
| Dimension        | Ø120x135 (mm) Diameter x length             | Gasket               | O-ring PMQ silicone seal                               |
| Cut out          | Ø100x145 (mm) Diameter x length             | Accessories          |  |
| Net weight       | 0.83kg                                      | Mounting Sleeve      | Anti-corrosion PVC. Black                              |
| Warranty         | 3 Years                                     | Clip                 | /  |
| Certifications   | CE, RoHS                                    |                      |  |
| Electrical Data  |   |                      |  |
| Input voltage    | 90-265V AC                                  |                      |  |
| Insulation class | Class I                                     |                      |  |
| Cable            | 1PC rubber cable 1M H05RN-F 3x0.75mm square |                      |  |
| Driver           | /   |                      |  |

● 6000K ● 5000K ● 4000K ● 3000K ● 2700K

max.50W  
GU10

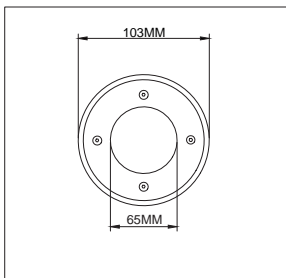
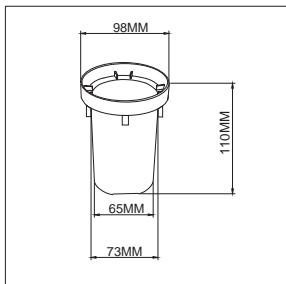
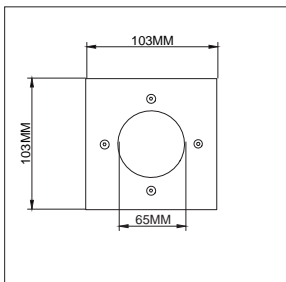

| Parameter            |   |
|----------------------|---|
| General Data         |   |
| Name:                | GU10 Underground Light                      |
| Item No.             | DMD-GU10                                    |
| Power                | Max 50W                                     |
| Base type            | GU10  |
| Luminous flux        | /   |
| CCT                  | /   |
| CRI                  | /   |
| Beam angle           | /   |
| Dimension            | Ø103x110 (mm) Diameter x length             |
| Cut out              | Ø100x120 (mm) Diameter x length             |
| Net weight           |   |
| Warranty             | 3 Years                                     |
| Certifications       | CE, RoHS                                    |
| Electrical Data      |   |
| Input voltage        | 90-265V AC                                  |
| Insulation class     | Class I                                     |
| Cable                | 1PC rubber cable 1M H05RN-F 3x0.75mm square |
| Driver               | /   |
| Construction Data    |   |
| IP rating            | IP67 Waterproof                             |
| IK rating            | IK08  |
| Housing              | Die casting Aluminum                        |
| Protection finishing | Anti-corrosion coating 90~100µm thickness   |
| Trim                 | Stainless steel 304 or 316                  |
| Glass                | Step tempered Glass. T=8mm.                 |
| Loading capacity     | 500 kgs                                     |
| Cable Gland          | PG7 IP67                                    |
| Gasket               | O-ring PMQ silicone seal                    |
| Accessories          |   |
| Mounting Sleeve      | Anti-corrosion PVC. Black                   |

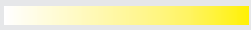

● 6000K ● 5000K ● 4000K ● 3000K ● 2700K

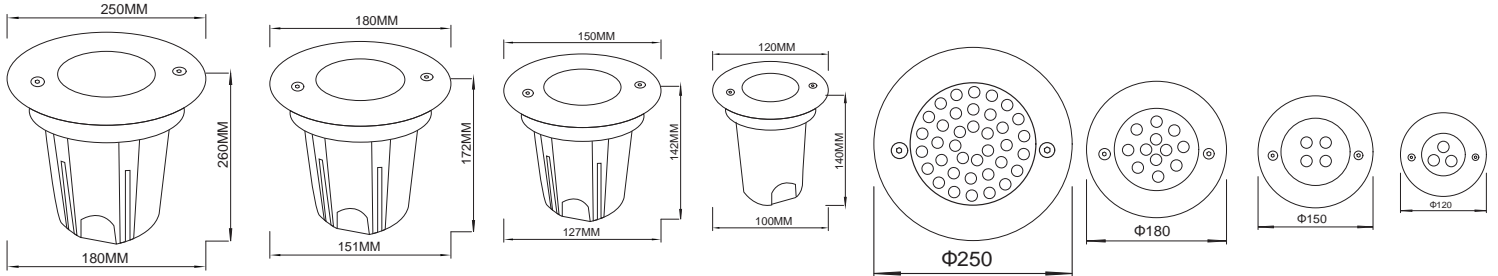

|                     |                                     |                          |  |
|---------------------|-------------------------------------|--------------------------|--|
| Parameter           |                                     |                          |  |
| <b>General Data</b> |                                     | Cable                    | 1PC rubber cable 1M H05RN-F 3x1.0mm square |
| Name:               | LED 1W-36W Underground Light        | Driver                   | Eaglerise                                  |
| Item No.            | Please see table below              | <b>Construction Data</b> |  |
| Power               | 3W, 6W, 9W, 12W, 18W, 24W, 36W      | IP rating                | IP67 Waterproof                            |
| LED type            | CREE/Brigelux/Osram                 | IK rating                | IK08                                       |
| Luminous flux       | 80lm/W                              | Housing                  | Die casting ADC #12 Aluminum               |
| CCT                 | 2700K, 3000K, 4000K, 6000K, R/G/Y/B | Protection finishing     | Anti-corrosion coating 90~100µm thickness  |
| CRI                 | 80+                                 | Trim                     | SUS316                                     |
| Beam angle          | 10°, 15°, 30°, 45°, 60°, 90°, 120°  | Glass                    | Step tempered Glass. T=8mm.                |
| Dimension           | Please see table below              | Loading capacity         | 500 kgs                                    |
| Cut out             | Please see table below              | Cable Gland              | PG7 IP67                                   |
| Warranty            | 3 Years                             | Gasket                   | O-ring PMQ silicone seal                   |
| Certifications      | CE, RoHS                            | <b>Accessories</b>       |  |
| Electrical Data     |                                     | Mounting Sleeve          | Anti-corrosion PVC. Black                  |
| Input voltage       | 90-265V AC                          |                          |  |
| Insulation class    | Class I                             |                          |  |

| Power | Model  | Chip Brand          | Driver brand | Material                | Dimension  |
|-------|--------|---------------------|--------------|-------------------------|------------|
| 3W    | UG601A | CREE/Brigelux/Osram | Eaglerise    | SUS316+ ADC#12 Aluminum | Ø120x140mm |
| 6W    | UG602A | CREE/Brigelux/Osram | Eaglerise    | SUS316+ ADC#12 Aluminum | Ø150x142mm |
| 9W    | UG603A | CREE/Brigelux/Osram | Eaglerise    | SUS316+ ADC#12 Aluminum | Ø150x142mm |
| 12W   | UG604A | CREE/Brigelux/Osram | Eaglerise    | SUS316+ ADC#12 Aluminum | Ø180x172mm |
| 24W   | UG606A | CREE/Brigelux/Osram | Eaglerise    | SUS316+ ADC#12 Aluminum | Ø250x260mm |
| 36W   | UG607A | CREE/Brigelux/Osram | Eaglerise    | SUS316+ ADC#12 Aluminum | Ø250x260mm |

● 6000K ● 5000K ● 4000K ● 3000K ● 2700K

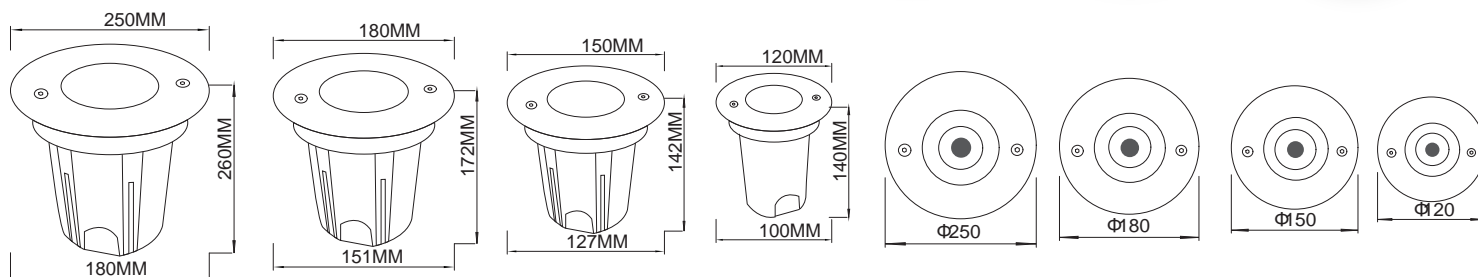

|                  |                                     |                      |  |
|------------------|-------------------------------------|----------------------|--|
| Parameter        |                                     | Cable                | 1PC rubber cable 1M H05RN-F 3x1.0mm square |
| General Data     |                                     | Driver               | Eaglerise                                  |
| Name:            | LED COB 5W-30W Underground Light    | Construction Data    |  |
| Item No.         | Please see table below              | IP rating            | IP67 Waterproof                            |
| Power            | 5W,10W,15W, 20W, 30W                | IK rating            | IK08                                       |
| LED type         | CREE/Brigelux/Osram COB             | Housing              | Die casting ADC #12 Aluminum               |
| Luminous flux    | 80lm/W                              | Protection finishing | Anti-corrosion coating 90~100µm thickness  |
| CCT              | 2700K, 3000K, 4000K, 6000K, R/G/Y/B | Trim                 | SUS316                                     |
| CRI              | 80+                                 | Glass                | Step tempered Glass. T=8mm.                |
| Beam angle       | 60°                                 | Loading capacity     | 500 kgs                                    |
| Dimension        | Please see table below              | Cable Gland          | PG7 IP67                                   |
| Cut out          | Please see table below              | Gasket               | O-ring PMQ silicone seal                   |
| Warranty         | 3 Years                             | Accessories          |  |
| Certifications   | CE, RoHS                            | Mounting Sleeve      | Anti-corrosion PVC. Black                  |
| Electrical Data  |                                     |                      |  |
| Input voltage    | 90-265V AC                          |                      |  |
| Insulation class | Class I                             |                      |  |

| Power | Model  | Chip Brand          | Driver brand | Material                | Dimension  |
|-------|--------|---------------------|--------------|-------------------------|------------|
| 5W    | UG601A | CREE/Brigelux/Osram | Eaglerise    | SUS316+ ADC#12 Aluminum | Ø120x140mm |
| 10W   | UG602A | CREE/Brigelux/Osram | Eaglerise    | SUS316+ ADC#12 Aluminum | Ø150x142mm |
| 15W   | UG604A | CREE/Brigelux/Osram | Eaglerise    | SUS316+ ADC#12 Aluminum | Ø180x172mm |
| 20W   | UG606A | CREE/Brigelux/Osram | Eaglerise    | SUS316+ ADC#12 Aluminum | Ø250x260mm |
| 30W   | UG607A | CREE/Brigelux/Osram | Eaglerise    | SUS316+ ADC#12 Aluminum | Ø250x260mm |



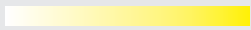

● 6000K ● 5000K ● 4000K ● 3000K ● 2700K

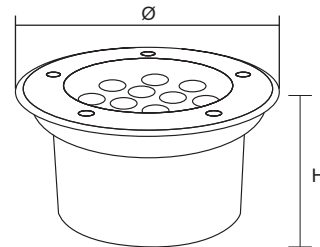

|                                    |  |                          |  |
|------------------------------------|--|--------------------------|--|
| <b>Parameter General Data</b>      |  | Cable                    | 1PC rubber cable 1M H05RN-F 3x1.0mm square |
| Name: LED 1W-36W Underground Light |  | Driver                   | Eaglerise                                  |
| <b>Item No.</b>                    |  | <b>Construction Data</b> |  |
| Please see table below             |  | IP rating                | IP67 Waterproof                            |
| Power                              | 1W, 3W, 5W, 6W,7W,9W,12W,15W,18W,24W,36W | IK rating                | IK08                                       |
| LED type                           | CREE/Brigelux/Osram                      | Housing                  | SUS304/316+Die casting Aluminum            |
| Luminous flux                      | 80lm/W                                   | Protection finishing     | Anti-corrosion coating 90~100µm thickness  |
| CCT                                | 2700K, 3000K, 4000K, 6000K, R/G/Y/B      | Trim                     | SUS304/316                                 |
| CRI                                | 80+                                      | Glass                    | Step tempered Glass. T=8mm.                |
| Beam angle                         | 10°,15°, 30°, 45°, 60°, 90°, 120°        | Loading capacity         | 500 kgs                                    |
| Dimension                          | Please see table below                   | Cable Gland              | PG7 IP67                                   |
| Cut out                            | Please see table below                   | Gasket                   | O-ring PMQ silicone seal                   |
| Warranty                           | 3 Years                                  | <b>Accessories</b>       |  |
| Certifications                     | CE, RoHS                                 | Mounting Sleeve          | Anti-corrosion PVC. Black                  |
| <b>Electrical Data</b>             |  |                          |  |
| Input voltage                      | 90-265V AC                               |                          |  |
| Insulation class                   | Class I                                  |                          |  |

| Power | Model     | Chip Brand          | Driver brand | Material                    | Dimension   | Cutout      |
|-------|-----------|---------------------|--------------|-----------------------------|-------------|-------------|
| 1W    | DMD-1X1W  | CREE/Brigelux/Osram | Eaglerise    | SUS316+Die casting Aluminum | Ø65x H80mm  | Ø60x H80mm  |
| 3W    | DMD-3X1W  | CREE/Brigelux/Osram | Eaglerise    | SUS316+Die casting Aluminum | Ø80x H80mm  | Ø75x H80mm  |
| 3W    | DMD-3X1W  | CREE/Brigelux/Osram | Eaglerise    | SUS316+Die casting Aluminum | Ø100x H90mm | Ø95x H90mm  |
| 5W    | DMD-5X1W  | CREE/Brigelux/Osram | Eaglerise    | SUS316+Die casting Aluminum | Ø120x H90mm | Ø115x H90mm |
| 6W    | DMD-6X1W  | CREE/Brigelux/Osram | Eaglerise    | SUS316+Die casting Aluminum | Ø130x H90mm | Ø115x H90mm |
| 7W    | DMD-7X1W  | CREE/Brigelux/Osram | Eaglerise    | SUS316+Die casting Aluminum | Ø150x H90mm | Ø125x H90mm |
| 9W    | DMD-9X1W  | CREE/Brigelux/Osram | Eaglerise    | SUS316+Die casting Aluminum | Ø160x H90mm | Ø140x H90mm |
| 12W   | DMD-12X1W | CREE/Brigelux/Osram | Eaglerise    | SUS316+Die casting Aluminum | Ø180x H95mm | Ø155x H90mm |
| 15W   | DMD-15X1W | CREE/Brigelux/Osram | Eaglerise    | SUS316+Die casting Aluminum | Ø200x H95mm | Ø185x H90mm |
| 18W   | DMD-18X1W | CREE/Brigelux/Osram | Eaglerise    | SUS316+Die casting Aluminum | Ø220x H95mm | Ø205x H90mm |
| 24W   | DMD-24X1W | CREE/Brigelux/Osram | Eaglerise    | SUS316+Die casting Aluminum | Ø250x H95mm | Ø235x H90mm |
| 36W   | DMD-36X1W | CREE/Brigelux/Osram | Eaglerise    | SUS316+Die casting Aluminum | Ø300x H95mm | Ø295x H90mm |

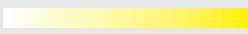

● 6000K ● 5000K ● 4000K ● 3000K ● 2700K

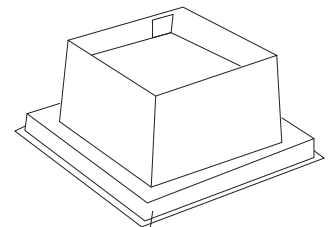
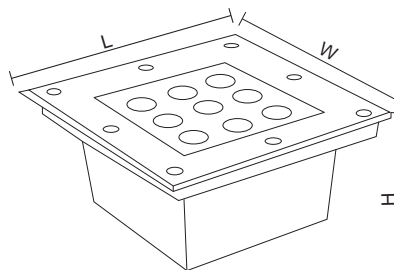

|                  |                                     |                      |  |
|------------------|-------------------------------------|----------------------|--|
| Parameter        |                                     | Cable                | 1PC rubber cable 1M H05RN-F 3x1.0mm square |
| General Data     |                                     | Driver               | Eaglerise                                  |
| Name:            | LED 3W-36W Linear Underground Light | Construction Data    |  |
| Item No.         | Please see table below              | IP rating            | IP67 Waterproof                            |
| Power            | 3W, 6W, 12W, 18W,24W,36W            | IK rating            | IK08                                       |
| LED type         | CREE/Brigelux/Osram                 | Housing              | SUS304/316+Die casting Aluminum            |
| Luminous flux    | 80lm/W                              | Protection finishing | Anti-corrosion coating 90~100µm thickness  |
| CCT              | 2700K, 3000K, 4000K, 6000K, R/G/Y/B | Trim                 | SUS304/316                                 |
| CRI              | 80+                                 | Glass                | Step tempered Glass. T=8mm.                |
| Beam angle       | 10°, 15°, 30°, 45°, 60°, 90°, 120°  | Loading capacity     | 500 kgs                                    |
| Dimension        | Please see table below              | Cable Gland          | PG7 IP67                                   |
| Cut out          | Please see table below              | Gasket               | O-ring PMQ silicone seal                   |
| Warranty         | 3 Years                             | Accessories          |  |
| Certifications   | CE, RoHS                            | Mounting Sleeve      | Anti-corrosion PVC. Black                  |
| Electrical Data  |                                     |                      |  |
| Input voltage    | 90-265V AC                          |                      |  |
| Insulation class | Class I                             |                      |  |

| Power | Model     | Chip Brand          | Driver brand | Material                    | Dimension    | Cutout          |
|-------|-----------|---------------------|--------------|-----------------------------|--------------|-----------------|
| 3W    | DMF-3X1W  | CREE/Brigelux/Osram | Eaglerise    | SUS316+Die casting Aluminum | 95x95x90mm   | L90xW90xH90mm   |
| 4W    | DMF-4X1W  | CREE/Brigelux/Osram | Eaglerise    | SUS316+Die casting Aluminum | 120x120x90mm | L115xW115xH90mm |
| 5W    | DMF-5X1W  | CREE/Brigelux/Osram | Eaglerise    | SUS316+Die casting Aluminum | 140x140x90mm | L135xW135xH90mm |
| 9W    | DMF-9X1W  | CREE/Brigelux/Osram | Eaglerise    | SUS316+Die casting Aluminum | 150x150x90mm | L135xW135xH90mm |
| 9W    | DMF-9X1W  | CREE/Brigelux/Osram | Eaglerise    | SUS316+Die casting Aluminum | 160x160x90mm | L155xW155xH90mm |
| 12W   | DMF-12X1W | CREE/Brigelux/Osram | Eaglerise    | SUS316+Die casting Aluminum | 190x190x90mm | L180xW180xH90mm |
| 18W   | DMF-18X1W | CREE/Brigelux/Osram | Eaglerise    | SUS316+Die casting Aluminum | 200x200x90mm | L185xW185xH90mm |
| 24W   | DMF-24X1W | CREE/Brigelux/Osram | Eaglerise    | SUS316+Die casting Aluminum | 220x220x90mm | L205xW205xH90mm |
| 24W   | DMF-24X1W | CREE/Brigelux/Osram | Eaglerise    | SUS316+Die casting Aluminum | 250x250x90mm | L235xW235xH90mm |
| 36W   | DMF-36X1W | CREE/Brigelux/Osram | Eaglerise    | SUS316+Die casting Aluminum | 300x300x90mm | L285xW285xH90mm |

● 6000K ● 5000K ● 4000K ● 3000K ● 2700K

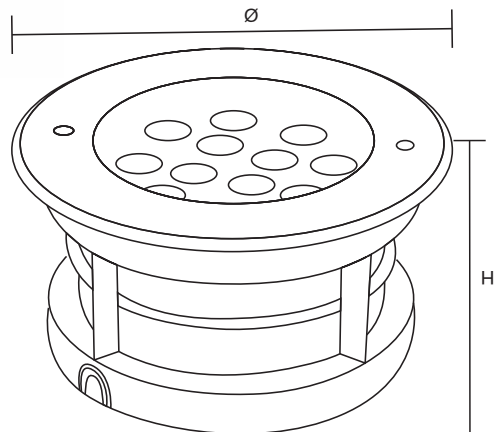

|  |                                     |                      |  |
|--|-------------------------------------|----------------------|--|
| Parameter                              |                                     | Cable                | 1PC rubber cable 1M H05RN-F 3x1.0mm square |
| General Data                           |                                     | Driver               | Eaglerise                                  |
| Name: LED COB 6W-48W Underground Light |                                     | Construction Data    |  |
| Item No.                               | Please see table below              | IP rating            | IP67 Waterproof                            |
| Power                                  | 6W, 9W, 12W, 18W,24W,36W, 48W       | IK rating            | IK08                                       |
| LED type                               | CREE/Brigelux/Osram                 | Housing              | Die casting ADC #12 Aluminum               |
| Luminous flux                          | 80lm/W                              | Protection finishing | Anti-corrosion coating 90~100µm thickness  |
| CCT                                    | 2700K, 3000K, 4000K, 6000K, R/G/Y/B | Trim                 | SUS316                                     |
| CRI                                    | 80+                                 | Glass                | Step tempered Glass. T=8mm.                |
| Beam angle                             | 10°, 15°, 30°, 45°, 60°, 90°, 120°  | Loading capacity     | 500 kgs                                    |
| Dimension                              | Please see table below              | Cable Gland          | PG7 IP67                                   |
| Cut out                                | Please see table below              | Gasket               | O-ring PMQ silicone seal                   |
| Warranty                               | 3 Years                             | Accessories          |  |
| Certifications                         | CE, RoHS                            | Mounting Sleeve      | Anti-corrosion PVC. Black                  |
| Electrical Data                        |                                     |                      |  |
| Input voltage                          | 90-265V AC                          |                      |  |
| Insulation class                       | Class I                             |                      |  |

| Power | Model     | Chip Brand          | Driver brand | Material                     | Dimension | Cutout      |
|-------|-----------|---------------------|--------------|------------------------------|-----------|-------------|
| 6W    | DMW-6X1W  | CREE/Brigelux/Osram | Eaglerise    | SUS316+ Die casting Aluminum | Ø150x90mm | Ø125xH100mm |
| 9W    | DMW-9X1W  | CREE/Brigelux/Osram | Eaglerise    | SUS316+ Die casting Aluminum | Ø160x90mm | Ø140xH100mm |
| 12W   | DMW-12X1W | CREE/Brigelux/Osram | Eaglerise    | SUS316+ Die casting Aluminum | Ø180x90mm | Ø155xH100mm |
| 18W   | DMW-18X1W | CREE/Brigelux/Osram | Eaglerise    | SUS316+ Die casting Aluminum | Ø200x90mm | Ø185xH100mm |
| 24W   | DMW-24X1W | CREE/Brigelux/Osram | Eaglerise    | SUS316+ Die casting Aluminum | Ø220x90mm | Ø205xH100mm |
| 36W   | DMW-36X1W | CREE/Brigelux/Osram | Eaglerise    | SUS316+ Die casting Aluminum | Ø250x90mm | Ø235xH100mm |
| 48W   | DMW-48X1W | CREE/Brigelux/Osram | Eaglerise    | SUS316+ Die casting Aluminum | Ø300x90mm | Ø295xH100mm |

● 6000K ● 5000K ● 4000K ● 3000K ● 2700K

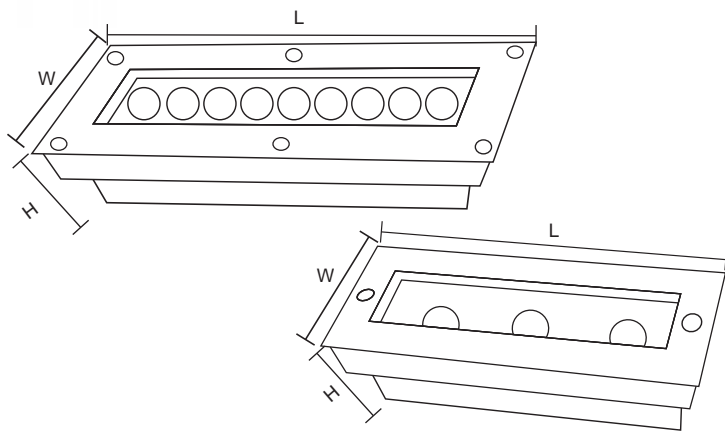

|   |                                     |                      |  |
|---|-------------------------------------|----------------------|--|
| Parameter                                 |                                     | Insulation class     | Class I                                    |
| General Data                              |                                     | Cable                | 1PC rubber cable 1M H05RN-F 3x1.0mm square |
| Name: LED 3W-36W Linear Underground Light |                                     | Driver               | Eaglerise                                  |
| Item No.                                  | Please see table below              | Construction Data    |  |
| Power                                     | 3W, 6W, 12W, 18W, 24W, 36W          | IP rating            | IP67 Waterproof                            |
| LED type                                  | CREE/Brigelux/Osram                 | IK rating            | IK08                                       |
| Luminous flux                             | 80lm/W                              | Housing              | SUS304/316+Die casting Aluminum            |
| CCT                                       | 2700K, 3000K, 4000K, 6000K, R/G/Y/B | Protection finishing | Anti-corrosion coating 90~100µm thickness  |
| CRI                                       | 80+                                 | Trim                 | SUS304/316                                 |
| Beam angle                                | 10°, 15°, 30°, 45°, 60°, 90°, 120°  | Glass                | Step tempered Glass. T=8mm.                |
| Dimension                                 | Please see table below              | Loading capacity     | 500 kgs                                    |
| Cut out                                   | Please see table below              | Cable Gland          | PG7 IP67                                   |
| Warranty                                  | 3 Years                             | Gasket               | O-ring PMQ silicone seal                   |
| Certifications                            | CE, RoHS                            | Accessories          |  |
| Electrical Data                           |                                     | Mounting Sleeve      | Anti-corrosion PVC. Black                  |
| Input voltage                             | 90-265V AC                          |                      |  |

| Power | Model     | Chip Brand          | Driver brand | Material                       | Dimension | Cutout    |
|-------|-----------|---------------------|--------------|--------------------------------|-----------|-----------|
| 3W    | DML-3X1W  | CREE/Brigelux/Osram | Eaglerise    | SS316<br>+Die casting Aluminum | 200x80mm  | 190x75mm  |
| 6W    | DML-3X1W  | CREE/Brigelux/Osram | Eaglerise    | SS316                          | 300x90mm  | 190x75mm  |
| 12W   | DML-12X1W | CREE/Brigelux/Osram | Eaglerise    | +Die casting Aluminum          | 500x90mm  | 485x75mm  |
| 18W   | DML-18X1W | CREE/Brigelux/Osram | Eaglerise    | SS316                          | 650x90mm  | 635x75mm  |
| 24W   | DML-24X1W | CREE/Brigelux/Osram | Eaglerise    | +Die casting Aluminum          | 1000x90mm | 985x75mm  |
| 36W   | DML-36X1W | CREE/Brigelux/Osram | Eaglerise    | SS316                          | 1200x90mm | 1185x75mm |

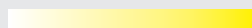

● 6000K ● 5000K ● 4000K ● 3000K ● 2700K

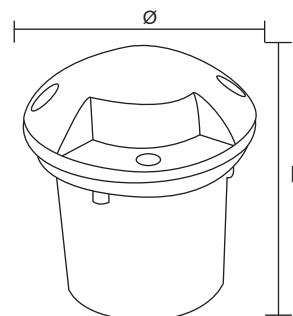
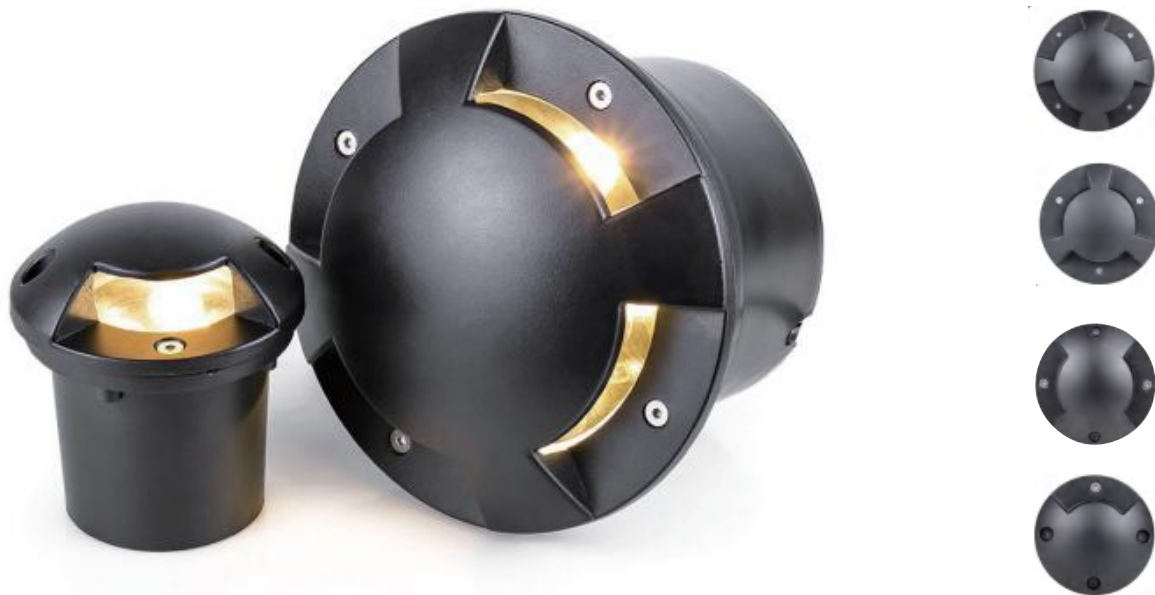

|  |                                     |                      |  |
|--|-------------------------------------|----------------------|--|
| Parameter General Data                               |                                     | Cable                | 1PC rubber cable 1M H05RN-F 3x1.0mm square |
| Name: LED COB 3W-24W Side Emitting Underground Light |                                     | Driver               | Eaglerise                                  |
| Item No.   | Please see table below              | Construction Data    |  |
| Power  | 3W, 5W, 6W, 9W, 12W, 18W,           | IP rating            | IP67 Waterproof                            |
| LED type   | CREE/Brigelux/Osram                 | IK rating            | IK08                                       |
| Luminous flux  | 50lm/W                              | Housing              | Die casting Aluminum                       |
| CCT  | 2700K, 3000K, 4000K, 6000K, R/G/Y/B | Protection finishing | Anti-corrosion coating 90~100µm thickness  |
| CRI  | 80+                                 | Trim                 | Die casting Aluminum                       |
| Beam angle   | C1, C2, C3, C4                      | Glass                | Step tempered Glass. T=8mm.                |
| Dimension  | Please see table below              | Loading capacity     | 500 kgs                                    |
| Cut out  | Please see table below              | Cable Gland          | PG7 IP67                                   |
| Warranty   | 3 Years                             | Gasket               | O-ring PMQ silicone seal                   |
| Certifications                                       | CE, RoHS                            | Accessories          |  |
| Input voltage  | 90-265V AC                          | Mounting Sleeve      | Anti-corrosion PVC. Black                  |
| Insulation class                                     | Class I                             |                      |  |

| Power | Model     | Chip Brand          | Driver brand | Material             | Dimension   | Cutout     |
|-------|-----------|---------------------|--------------|----------------------|-------------|------------|
| 3W    | DMH-3X1W  | CREE/Brigelux/Osram | Eaglerise    | Die casting Aluminum | Ø100xH120mm | Ø95x90mm   |
| 5W    | DMH-5X1W  | CREE/Brigelux/Osram | Eaglerise    | Die casting Aluminum | Ø120xH120mm | Ø116x90mm  |
| 6W    | DMH-6X1W  | CREE/Brigelux/Osram | Eaglerise    | Die casting Aluminum | Ø150xH120mm | Ø135x90mm  |
| 9W    | DMH-9X1W  | CREE/Brigelux/Osram | Eaglerise    | Die casting Aluminum | Ø160xH120mm | Ø145x100mm |
| 12W   | DMH-12X1W | CREE/Brigelux/Osram | Eaglerise    | Die casting Aluminum | Ø180xH120mm | Ø165x90mm  |
| 15W   | DMH-18X1W | CREE/Brigelux/Osram | Eaglerise    | Die casting Aluminum | Ø200xH120mm | Ø185x90mm  |

NELUX ARCHITECTURAL LIGHTING PRODUCTS

# 02

LED Garden Spike Light

● 6000K ● 5000K ● 4000K ● 3000K ● 2700K



20W



15W



10W



3W/5W

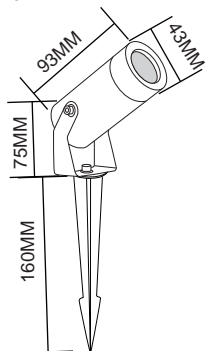
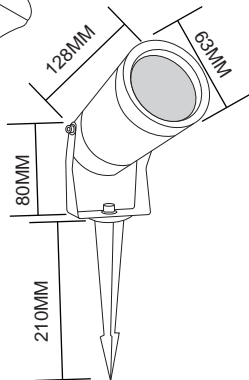
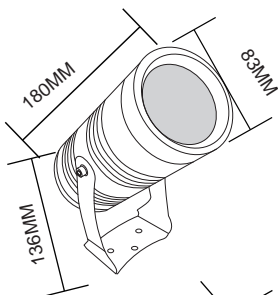
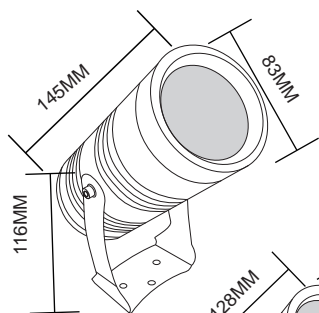

| Parameter            |   |
|----------------------|---|
| General Data         |   |
| Name:                | LED 3W/5W/10W/15W/20W COB Garden Spike Light  |
| Item No.             | SPCOB   |
| Power                | 3W/5W/10W/15W/20W   |
| LED type             | CREE/Brigelux/Osram   |
| Luminous flux        | 80lm/W  |
| CCT                  | 2700K, 3000K, 4000K, 6000K, R/G/Y/B   |
| CRI                  | 80+   |
| Beam angle           | 24°, 40°  |
| Dimension            | Please see table below  |
| Warranty             | 3 Years   |
| Certifications       | CE, RoHS  |
| Electrical Data      |   |
| Input voltage        | 90-265V AC or DC12, DC24V   |
| Insulation class     | Class I, Class III  |
| Cable                | 1PC rubber cable 1M H05RN-F 3x1.0mm square,<br>1PC rubber cable 1M H05RN-F 2x1.0mm square,<br>Eaglerise |
| Driver               |   |
| Eaglerise            |   |
| Construction Data    |   |
| IP rating            | IP67 Waterproof   |
| IK rating            | IK08  |
| Housing              | 6063 Aluminum   |
| Protection finishing | Anti-corrosion coating 90~100µm thickness   |
| Glass                | Step tempered Glass. T=8mm.   |
| Loading capacity     | 500 kgs   |
| Cable Gland          | PG7 IP67  |
| Gasket               | O-ring PMQ silicone seal  |
| Accessories          |   |
| Mounting Spike       | Aluminum  |

| Power | Model        | Chip Brand          | Driver brand | Material      | Dimension |
|-------|--------------|---------------------|--------------|---------------|-----------|
| 3W    | GA-SPCOB 3W  | CREE/Brigelux/Osram | Eaglerise    | 6063 Aluminum | Ø43x93mm  |
| 5W    | GA-SPCOB 5W  | CREE/Brigelux/Osram | Eaglerise    | 6063 Aluminum | Ø43x93mm  |
| 10W   | GA-SPCOB 10W | CREE/Brigelux/Osram | Eaglerise    | 6063 Aluminum | Ø63x128mm |
| 15W   | GA-SPCOB 15W | CREE/Brigelux/Osram | Eaglerise    | 6063 Aluminum | Ø83x145mm |
| 20W   | GA-SPCOB 20W | CREE/Brigelux/Osram | Eaglerise    | 6063 Aluminum | Ø83x180mm |

6000K 5000K 4000K 3000K 2700K

max.50W  
GU10

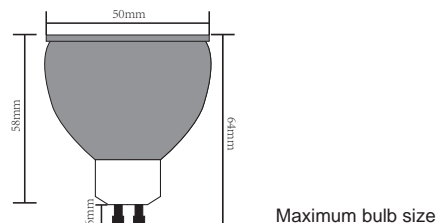
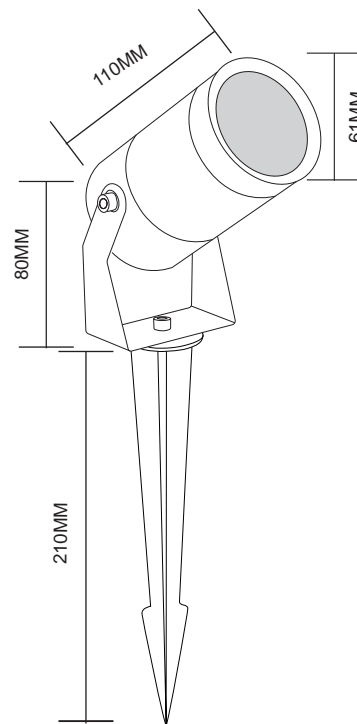

Maximum bulb size



|                      |   |
|----------------------|---|
| General Data         |   |
| Name:                | GU10 Garden Spike                           |
| Item No.             | SPH01                                       |
| Power                | Max 50W                                     |
| Base type            | GU10  |
| Dimension            | Ø61x110 (mm)                                |
| Net weight           | 0.6kg                                       |
| Warranty             | 3 Years                                     |
| Certifications       | CE, RoHS                                    |
| Electrical Data      |   |
| Input voltage        | 90-265V AC                                  |
| Insulation class     | Class I                                     |
| Cable                | 1PC rubber cable 1M H05RN-F 3x0.75mm square |
| Driver               | /   |
| Construction Data    |   |
| IP rating            | IP67 Waterproof                             |
| IK rating            | IK08  |
| Housing              | 6063 Aluminum                               |
| Protection finishing | Anti-corrosion coating 90~100µm thickness   |
| Glass                | Step tempered Glass. T=8mm.                 |
| Loading capacity     | 500 kgs                                     |
| Cable Gland          | PG7 IP67                                    |
| Gasket               | O-ring PMQ silicone seal                    |
| Accessories          |   |
| Mounting Spike       | Aluminum                                    |



● 6000K ● 5000K ● 4000K ● 3000K ● 2700K



max.50W  
GU10

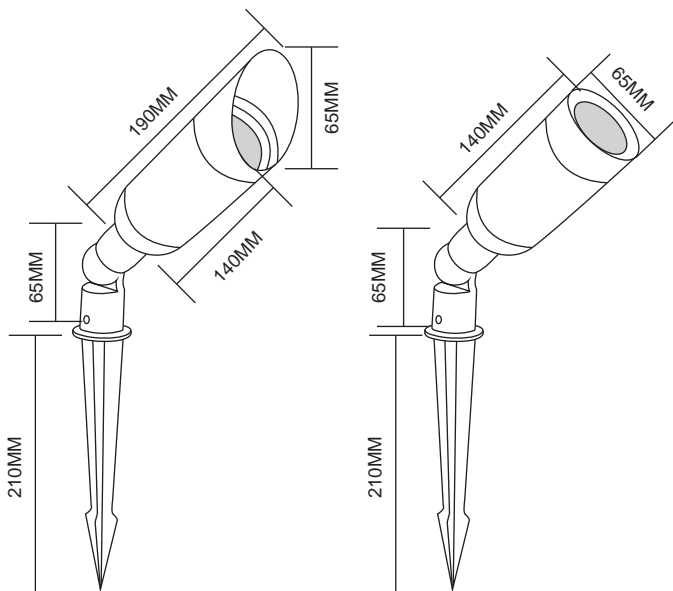
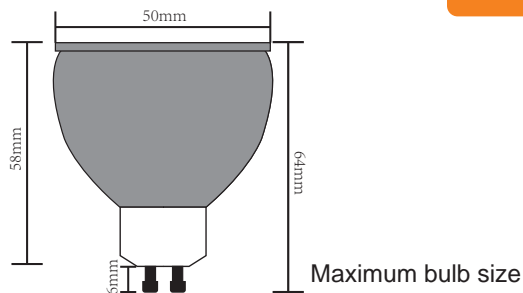

| Parameter                |  |
|--------------------------|--|
| <b>General Data</b>      |  |
| Name:                    | LED 10W/ GU10 Garden Spike Light   |
| Item No.                 | ENX10W   |
| Power                    | 10W  |
| LED type                 | CREE/Brigelux/Osram  |
| Luminous flux            | 80lm/W   |
| CCT                      | 2700K, 3000K, 4000K, 6000K, R/G/Y/B  |
| CRI                      | 80+  |
| Beam angle               | 15°, 25°, 40°  |
| Dimension                | Ø65mm  |
| Warranty                 | 3 Years  |
| Certifications           | CE, RoHS   |
| <b>Electrical Data</b>   |  |
| Input voltage            | 90-265V AC or DC12, DC24V  |
| Insulation class         | Class I, Class III   |
| Cable                    | 1PC rubber cable 1M H05RN-F 3x1.0mm square,<br>1PC rubber cable 1M H05RN-F 2x1.0mm square, |
| Driver                   | Eaglerise  |
| <b>Construction Data</b> |  |
| IP rating                | IP67 Waterproof  |
| IK rating                | IK08   |
| Housing                  | 6063 Aluminum  |
| Protection finishing     | Anti-corrosion coating 90~100µm thickness  |
| Glass                    | Step tempered Glass. T=8mm.  |
| Loading capacity         | 500 kgs  |
| Cable Gland              | PG7 IP67   |
| Gasket                   | O-ring PMQ silicone seal   |
| <b>Accessories</b>       |  |
| Mounting Spike           | Aluminum   |

# 03

LED Underwater Light

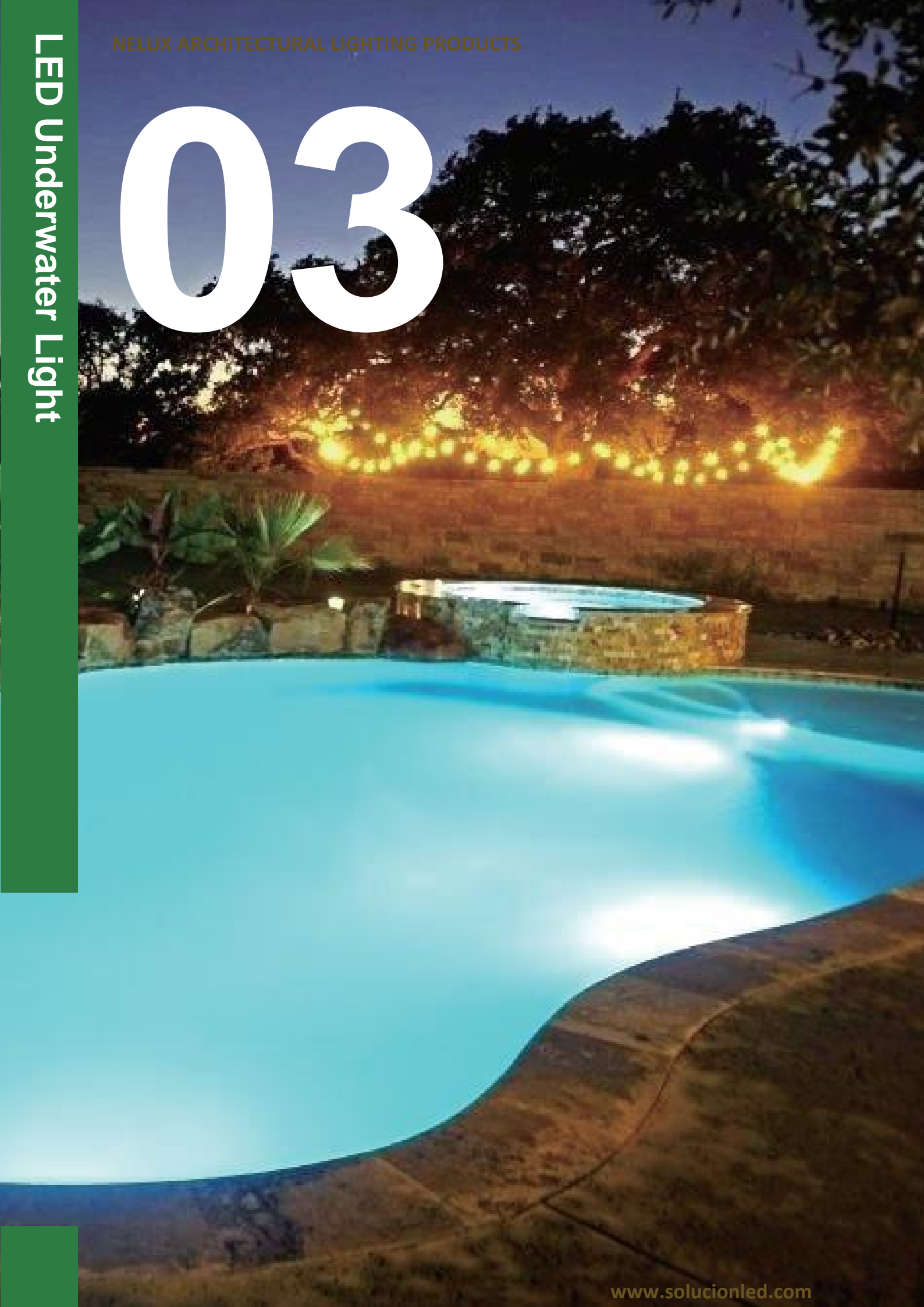

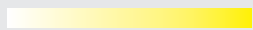

6000K 5000K 4000K 3000K 2700K

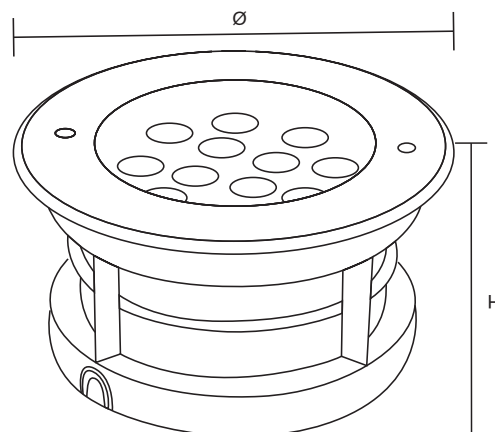

|                 |  |                      |   |
|-----------------|--|----------------------|---|
| Parameter       |  | Insulation class     | Class III                                   |
| General Data    |  | Cable                | 1PC rubber cable 1M H05RN-F 2x1.0mm square, |
| Name:           | LED 3W/5W/6W/9W/12W/18W Underwater Light | Driver               | Done  |
| Item No.        | Please see table below                   | Construction Data    |   |
| Power           | 3W/5W/6W/9W/12W/18W                      | IP rating            | IP68 Waterproof                             |
| LED type        | CREE/Brigelux/Osram                      | IK rating            | IK08  |
| Luminous flux   | 80lm/W                                   | Housing              | SUS304                                      |
| CCT             | 2700K, 3000K, 4000K, 6000K, R/G/Y/B      | Protection finishing | SUS   |
| CRI             | 80+                                      | Glass                | Step tempered Glass. T=10mm.                |
| Beam angle      | 30°, 45°, 60°, 90°, 120°                 | Loading capacity     | 500 kgs                                     |
| Dimension       | Please see table below                   | Cable Gland          | IP68  |
| Warranty        | 3 Years                                  | Gaske                | O-ring PMQ silicone seal                    |
| Certifications  | CE, RoHS                                 |                      |   |
| Electrical Data |  |                      |   |
| Input voltage   | DC12V                                    |                      |   |

| Power | Model | Chip Brand          | Driver brand | Material | Dimension   |
|-------|-------|---------------------|--------------|----------|-------------|
| 3W    | DMS   | CREE/Brigelux/Osram | Done         | SUS304   | Ø90xH90mm   |
| 3W    | DMS   | CREE/Brigelux/Osram | Done         | SUS304   | Ø100xH80mm  |
| 5W    | DMS   | CREE/Brigelux/Osram | Done         | SUS304   | Ø120xH90mm  |
| 6W    | DMS   | CREE/Brigelux/Osram | Done         | SUS304   | Ø130xH90mm  |
| 9W    | DMS   | CREE/Brigelux/Osram | Done         | SUS304   | Ø145xH90mm  |
| 12W   | DMS   | CREE/Brigelux/Osram | Done         | SUS304   | Ø160xH100mm |
| 12W   | DMS   | CREE/Brigelux/Osram | Done         | SUS304   | Ø170xH130mm |
| 18W   | DMS   | CREE/Brigelux/Osram | Done         | SUS304   | Ø200xH100mm |



6000K 5000K 4000K 3000K 2700K

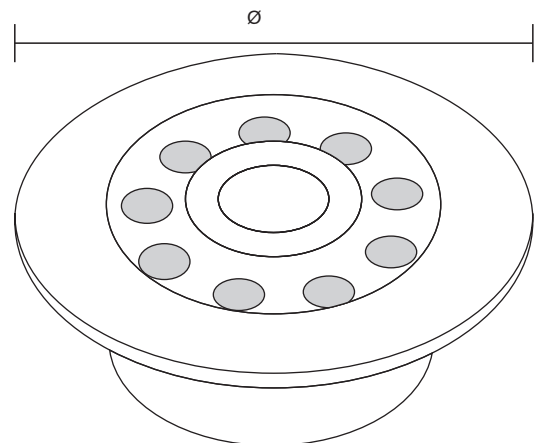

| Parameter                                      |   |
|--|---|
| General Data                                   |   |
| Name: LED 6W/9W/12W/15W/18W/24W Fountain Light |   |
| Item No.                                       | Please see table below                      |
| Power  | 6W/9W/12W/15W/18W/24W                       |
| LED type                                       | CREE/Brigelux/Osram                         |
| Luminous flux                                  | 80lm/W                                      |
| CCT  | 2700K, 3000K, 4000K, 6000K, R/G/Y/B         |
| CRI  | 80+   |
| Beam angle                                     | 30°, 45°, 60°, 90°, 120°                    |
| Dimension                                      | Please see table below                      |
| Warranty                                       | 3 Years                                     |
| Certifications                                 | CE, RoHS                                    |
| Electrical Data                                |   |
| Input voltage                                  | DC12,                                       |
| Insulation class                               | Class III                                   |
| Cable  | 1PC rubber cable 1M H05RN-F 2x1.0mm square, |
| Driver   | Done  |
| Construction Data                              |   |
| IP rating                                      | IP68 Waterproof                             |
| IK rating                                      | IK08  |
| Housing  | SUS304                                      |
| Protection finishing                           | SUS   |
| Glass  | Step tempered Glass. T=10mm.                |
| Loading capacity                               | 500 kgs                                     |
| Cable Gland                                    | IP68  |
| Gasket   | O-ring PMQ silicone seal                    |

| Power | Model  | Chip Brand          | Driver brand | Material | Dimension |
|-------|--------|---------------------|--------------|----------|-----------|
| 6W    | SDP6W  | CREE/Brigelux/Osram | Done         | SUS304   | Ø150mm    |
| 9W    | SDP9W  | CREE/Brigelux/Osram | Done         | SUS304   | Ø170mm    |
| 12W   | SDP12W | CREE/Brigelux/Osram | Done         | SUS304   | Ø180mm    |
| 15W   | SDP15W | CREE/Brigelux/Osram | Done         | SUS304   | Ø210mm    |
| 18W   | SDP18W | CREE/Brigelux/Osram | Done         | SUS304   | Ø230mm    |
| 24W   | SDP24W | CREE/Brigelux/Osram | Done         | SUS304   | Ø250mm    |

6000K 5000K 4000K 3000K 2700K

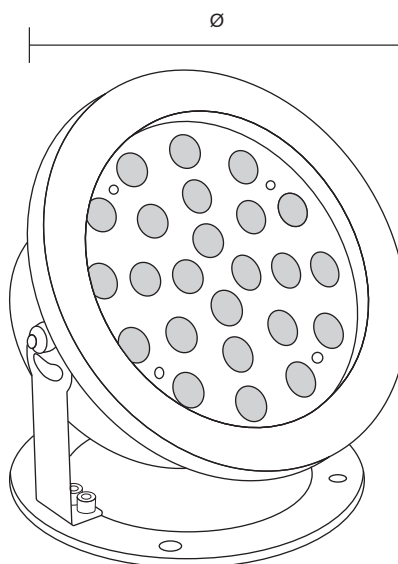

| Parameter            |  |
|----------------------|--|
| General Data         |  |
| Name:                | LED 6W/9W/12W/15W/18W/24W/36W Underwater Light |
| Item No.             | Please see table below                         |
| Power                | 6W/9W/12W/15W/18W/24W/36W                      |
| LED type             | CREE/Brigelux/Osram                            |
| Luminous flux        | 80lm/W   |
| CCT                  | 2700K, 3000K, 4000K, 6000K, R/G/Y/B            |
| CRI                  | 80+  |
| Beam angle           | 30°, 45°, 60°, 90°, 120°                       |
| Dimension            | Please see table below                         |
| Warranty             | 3 Years  |
| Certifications       | CE, RoHS                                       |
| Electrical Data      |  |
| Input voltage        | DC12   |
| Insulation class     | Class III                                      |
| Cable                | 1PC rubber cable 1M H05RN-F 2x1.0mm square,    |
| Driver               | Done   |
| Construction Data    |  |
| IP rating            | IP68 Waterproof                                |
| IK rating            | IK08   |
| Housing              | SUS304   |
| Protection finishing | SUS  |
| Glass                | Step tempered Glass. T=10mm.                   |
| Loading capacity     | 500 kgs  |
| Cable Gland          | IP68   |
| Gasket               | O-ring PMQ silicone seal                       |

| Power | Model  | Chip Brand          | Driver brand | Material | Dimension |
|-------|--------|---------------------|--------------|----------|-----------|
| 6W    | SDS6W  | CREE/Brigelux/Osram | Done         | SUS304   | Ø135mm    |
| 9W    | SDS9W  | CREE/Brigelux/Osram | Done         | SUS304   | Ø145mm    |
| 12W   | SDS12W | CREE/Brigelux/Osram | Done         | SUS304   | Ø170mm    |
| 15W   | SDS15W | CREE/Brigelux/Osram | Done         | SUS304   | Ø190mm    |
| 18W   | SDS18W | CREE/Brigelux/Osram | Done         | SUS304   | Ø215mm    |
| 24W   | SDS24W | CREE/Brigelux/Osram | Done         | SUS304   | Ø250mm    |
| 36W   | SDS36W | CREE/Brigelux/Osram | Done         | SUS304   | Ø300mm    |

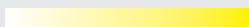

6000K 5000K 4000K 3000K 2700K

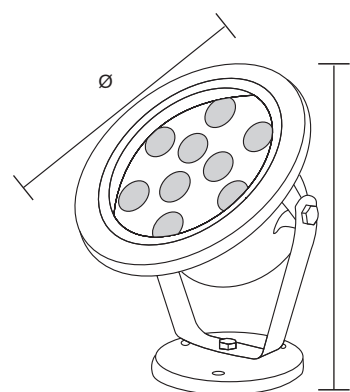

| Parameter                |  |
|--------------------------|--|
| <b>General Data</b>      |  |
| Name:                    | LED 3W/5W/7W/9W/12W/15W/18W/24W/36W Underwater Light |
| Item No.                 | Please see table below                               |
| Power                    | 3W/5W/7W/9W/12W/15W/18W/24W/36W                      |
| LED type                 | CREE/Brigelux/Osram                                  |
| Luminous flux            | 80lm/W   |
| CCT                      | 2700K, 3000K, 4000K, 6000K, R/G/Y/B                  |
| CRI                      | 80+  |
| Beam angle               | 30°, 45°, 60°, 90°, 120°                             |
| Dimension                | Please see table below                               |
| Warranty                 | 3 Years  |
| Certifications           | CE, RoHS   |
| <b>Electrical Data</b>   |  |
| Input voltage            | DC12V  |
| Insulation class         | Class III  |
| Cable                    | 1PC rubber cable 1M H05RN-F 2x1.0mm square,          |
| Driver                   | Done   |
| <b>Construction Data</b> |  |
| IP rating                | IP68 Waterproof                                      |
| IK rating                | IK08   |
| Housing                  | SUS304   |
| Protection finishing     | SUS  |
| Glass                    | Step tempered Glass. T=10mm.                         |
| Loading capacity         | 500 kgs  |
| Cable Gland              | IP68   |
| Gasket                   | O-ring PMQ silicone seal                             |

| Power | Model | Chip Brand          | Driver brand | Material | Dimension    |
|-------|-------|---------------------|--------------|----------|--------------|
| 3W    | SDH   | CREE/Brigelux/Osram | Done         | SUS304   | Ø90xH140mm   |
| 3W    | SDH   | CREE/Brigelux/Osram | Done         | SUS304   | Ø105xH155mm  |
| 3W    | SDH   | CREE/Brigelux/Osram | Done         | SUS304   | Ø105xH130mm  |
| 5-7W  | SDH   | CREE/Brigelux/Osram | Done         | SUS304   | Ø120xH150mm  |
| 6-9W  | SDH   | CREE/Brigelux/Osram | Done         | SUS304   | Ø145xH180mm  |
| 9-12W | SDH   | CREE/Brigelux/Osram | Done         | SUS304   | Ø160xH220mm  |
| 15W   | SDH   | CREE/Brigelux/Osram | Done         | SUS304   | Ø170xH225mm  |
| 18W   | SDH   | CREE/Brigelux/Osram | Done         | SUS304   | Ø190xH225mm  |
| 24W   | SDH   | CREE/Brigelux/Osram | Done         | SUS304   | Ø205xH265mm  |
| 36W   | SDH   | CREE/Brigelux/Osram | Done         | SUS304   | Ø230xH1250mm |

6000K 5000K 4000K 3000K 2700K

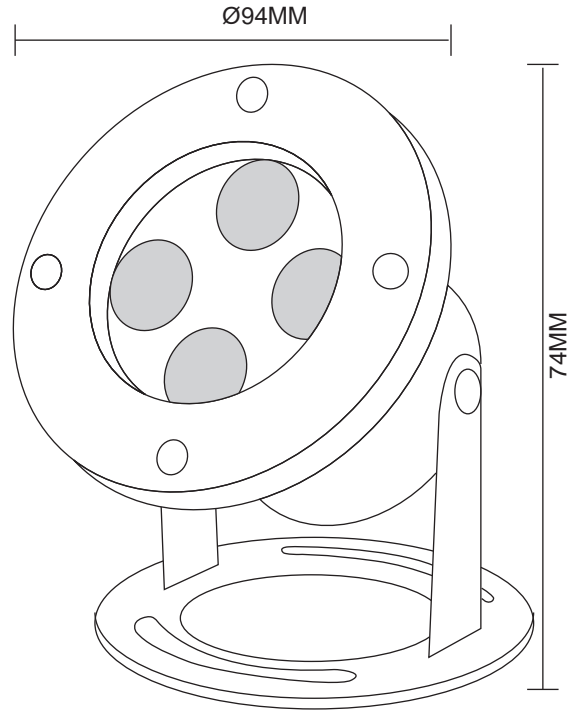

| Parameter            |   |
|----------------------|---|
| General Data         |   |
| Name:                | LED 3x1W, 3X3W, 4X1W,4X3W Underwater Light  |
| Item No.             | SDD   |
| Power                | 3x1W, 3X3W, 4X1W,4X3W                       |
| LED type             | CREE/Brigelux/Osram                         |
| Luminous flux        | 80lm/W                                      |
| CCT                  | 2700K, 3000K, 4000K, 6000K, R/G/Y/B         |
| CRI                  | 80+   |
| Beam angle           | 30°, 45°, 60°, 90°, 120°                    |
| Dimension            | Ø94x74mm                                    |
| Warranty             | 3 Years                                     |
| Certifications       | CE, RoHS                                    |
| Electrical Data      |   |
| Input voltage        | DC12V                                       |
| Insulation class     | Class III                                   |
| Cable                | 1PC rubber cable 1M H05RN-F 2x1.0mm square, |
| Driver               | Done  |
| Construction Data    |   |
| IP rating            | IP68 Waterproof                             |
| IK rating            | IK08  |
| Housing              | SUS304                                      |
| Protection finishing | SUS   |
| Glass                | Step tempered Glass. T=10mm.                |
| Loading capacity     | 500 kgs                                     |
| Cable Gland          | IP68  |
| Gasket               | O-ring PMQ silicone seal                    |

# 04

Outdoor LED Step Light





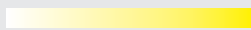

6000K 5000K 4000K 3000K 2700K

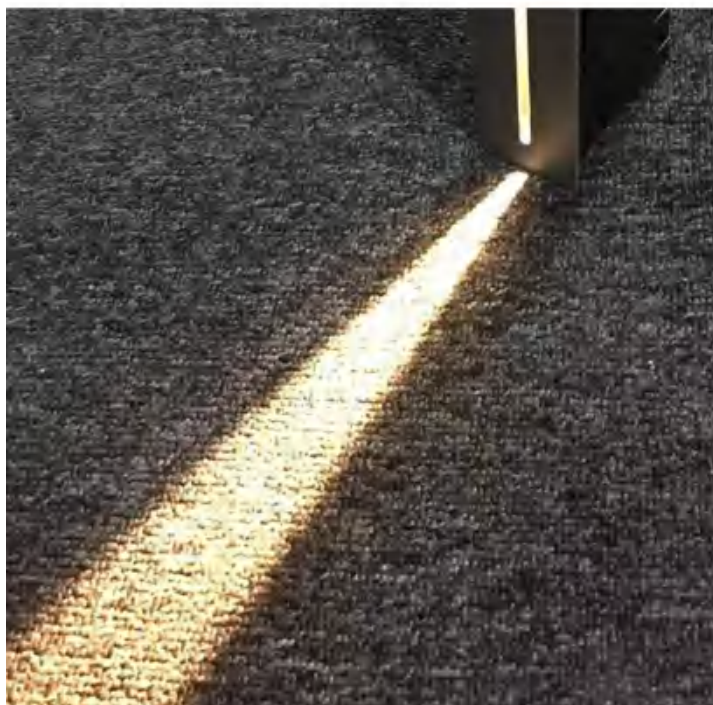

ST081, ST082, ST083 Name:  
Outdoor LED 3W Wall Light  
Power: 3W  
Input voltage: 100-265V AC 50/60Hz  
CRI:>80  
Die casting Aluminum  
Class: I  
Color: Silver Grey/Dark Grey/Black/White

Dimension:  
Dimension: ST081 105\*60\*60MM Cutout:101\*57\*52MM (S)  
ST082 180\*58\*80MM Cutout:175\*53\*75MM (M)  
ST083 210\*60\*55MM Cutout:205\*55\*50MM (L)

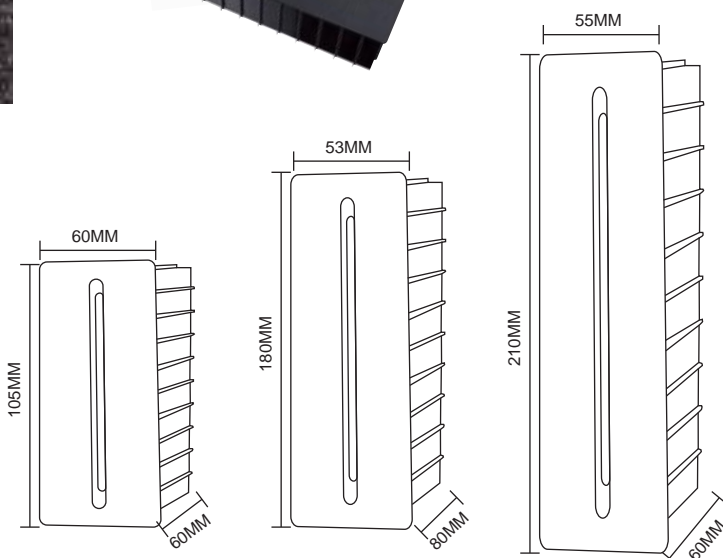

F868  
Name: Outdoor LED 3W Wall Light  
Power: 3W  
Input voltage: 100-265V AC 50/60Hz  
CRI:>80  
Die casting Aluminum  
Class: I  
Color: Silver Grey/Dark Grey/Black/White  
Dimension: 145X70X50mm  
Cutout:140\*65\*55mm

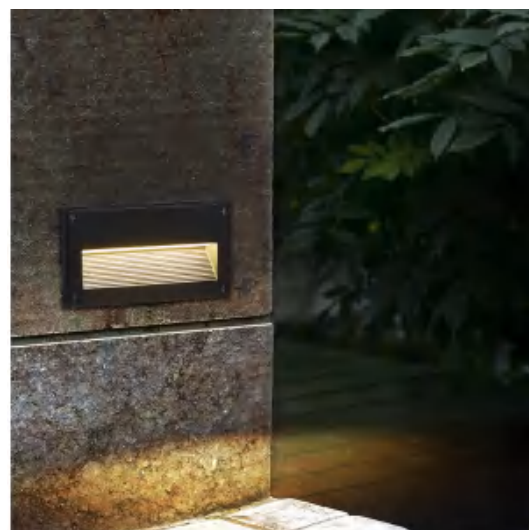
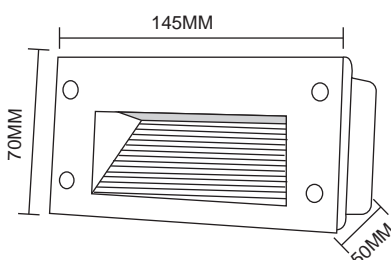

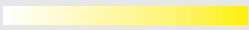

● 6000K ● 5000K ● 4000K ● 3000K ● 2700K

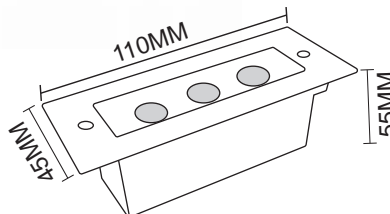
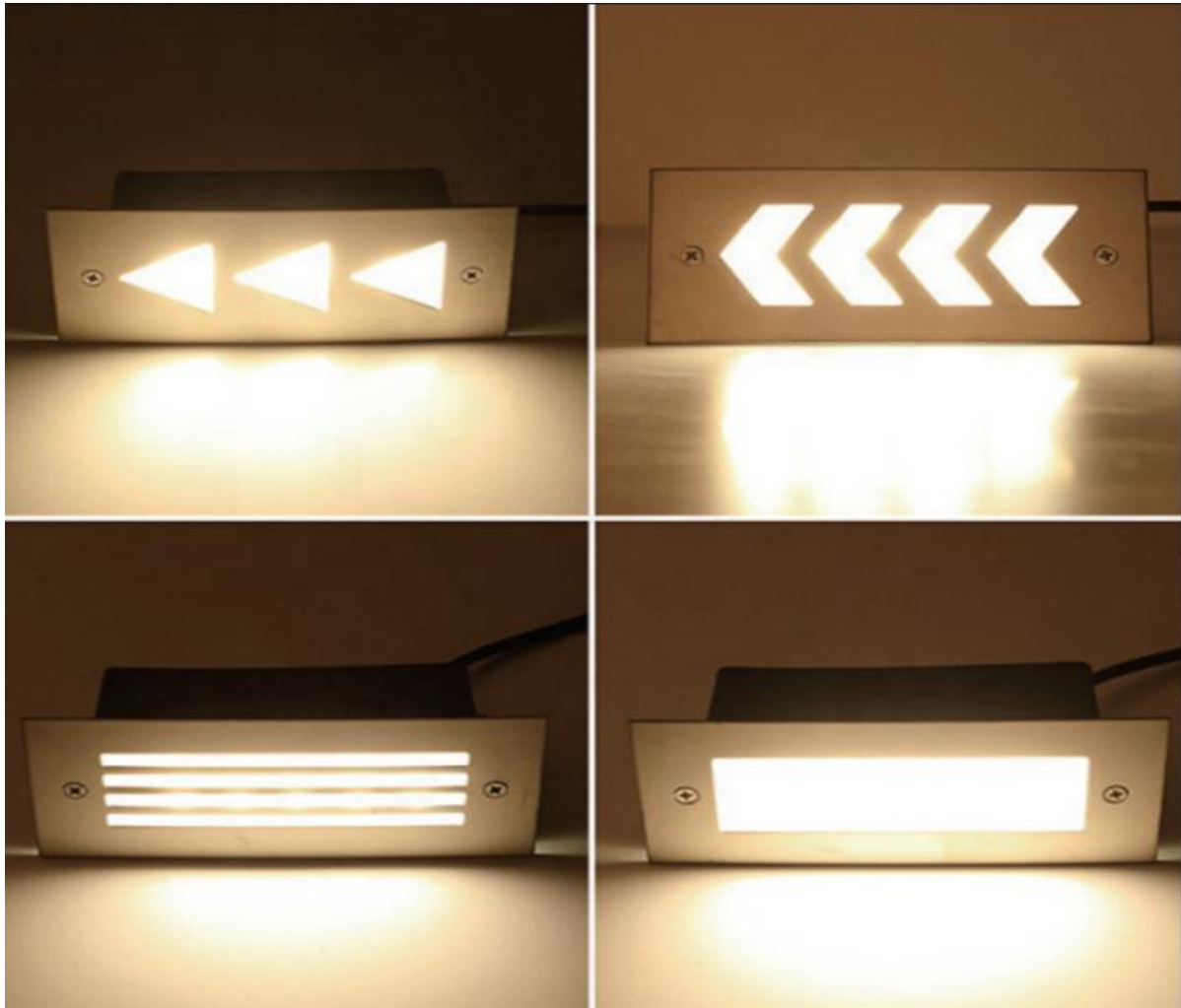

ST 25, ST26, ST27,  
 Name: Outdoor LED 3W/ 6W Recessed Step Light  
 Power: 3W/6W  
 Input voltage: 100-265V AC 50/60Hz  
 CRI:>80  
 SUS304/316+Die casting Aluminum  
 Class: I  
 Color: Silver Grey/Dark Grey/Black/White



| Power | Model | Chip Brand  | Driver brand | Material                            |             |
|-------|-------|-------------|--------------|-------------------------------------|-------------|
| 3W    | ST 25 | Epistar SMD | Eaglerise    | SUS316/ SUS304+Die casting Aluminum | 110x45x55mm |
| 3W    | ST 26 | Epistar SMD | Eaglerise    | SUS316/ SUS304+Die casting Aluminum | 110x45x55mm |
| 3W    | ST 27 | Epistar SMD | Eaglerise    | SUS316/ SUS304+Die casting Aluminum | 110x45x55mm |
| 6W    | ST 25 | Epistar SMD | Eaglerise    | SUS316/ SUS304+Die casting Aluminum | 170x70x55mm |
| 6W    | ST 26 | Epistar SMD | Eaglerise    | SUS316/ SUS304+Die casting Aluminum | 170x70x55mm |
| 6W    | ST 27 | Epistar SMD | Eaglerise    | SUS316/ SUS304+Die casting Aluminum | 170x70x55mm |



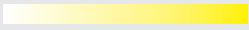

● 6000K ● 5000K ● 4000K ● 3000K ● 2700K

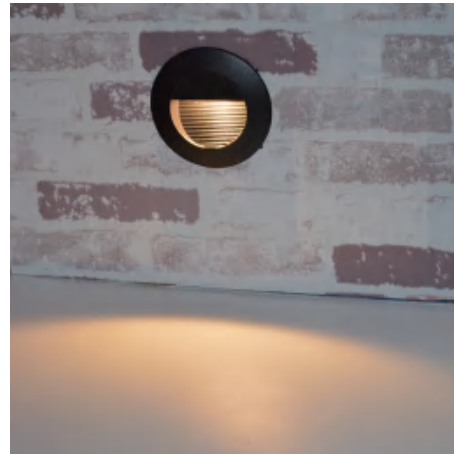

ST690S, WL690L  
 Name: Outdoor LED 1W/3W Recessed Step Light  
 Power: 1W/3W  
 Input voltage: 100-265V AC 50/60Hz  
 CRI:>80  
 Die casting Aluminum  
 Class: I  
 Color: Silver Grey/Dark Grey/Black/White



Dimension: 1W/55x55x45mm, 3W/80x80x50mm

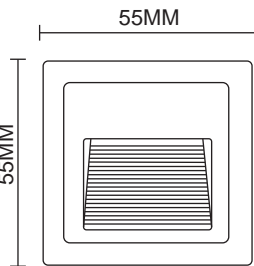

ST 690Y  
 Name: Outdoor LED 3W Recessed Step Light  
 Power: 3W  
 Input voltage: 100-265V AC 50/60Hz  
 CRI:>80  
 Die casting Aluminum  
 Class: I  
 Color: Silver Grey/Dark Grey/Black/White

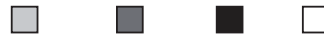

Dimension: φ85x50mm

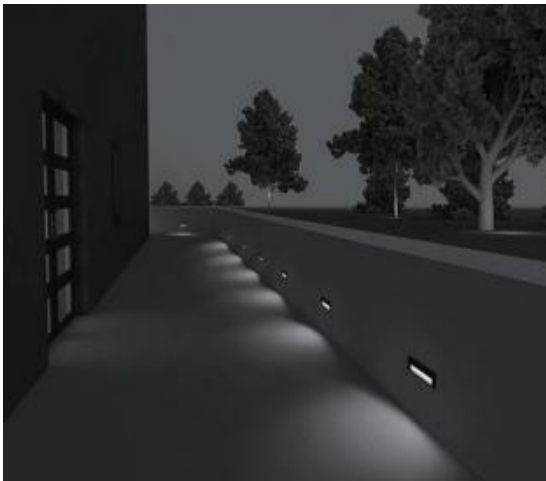
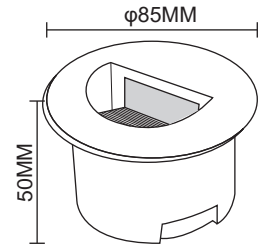

ST 691  
 Name: Outdoor LED 6W Surface Mounted Step Light  
 Power: 6W  
 Input voltage: 100-265V AC 50/60Hz  
 CRI:>80  
 Die casting Aluminum  
 Class: I  
 Color: Silver Grey/Dark Grey/Black/White



Dimension: 225x81x30mm

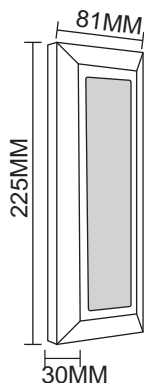

ST 692  
 Name: Outdoor LED 6W Surface Mounted Step Light  
 Power: 6W  
 Input voltage: 100-265V AC 50/60Hz  
 CRI:>80  
 Die casting Aluminum  
 Class: I  
 Color: Silver Grey/Dark Grey/Black/White



Dimension: 225x81x30mm

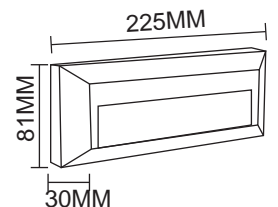



● 6000K ● 5000K ● 4000K ● 3000K ● 2700K



ST705S, ST705L  
 Name: Outdoor LED 3W/ 6W Recessed Step Light  
 Power: 3W/6W  
 Input voltage: 100-265V AC 50/60Hz  
 CRI:>80  
 Die casting Aluminum  
 Class: I  
 Color: Silver Grey/Dark Grey/Black/White



Dimension: 3W/105x60x60mm, 6W/ 210x65x60mm

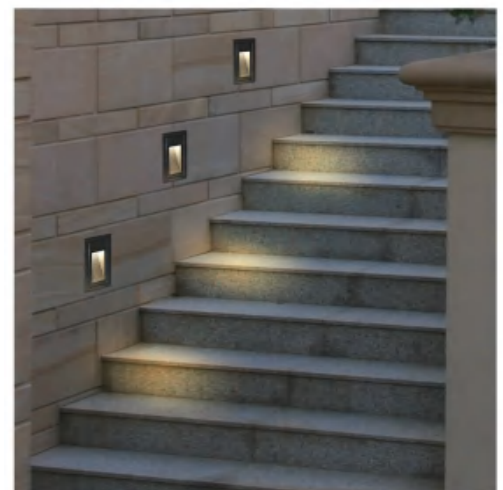
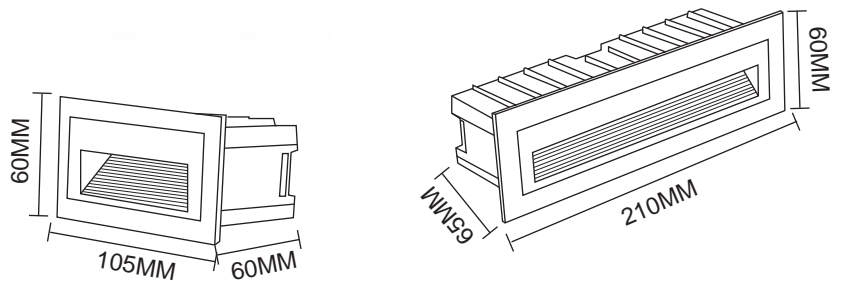

ST706S, ST 706L  
 Name: Outdoor LED 3W/ 6W Recessed Step Light  
 Power: 3W/6W  
 Input voltage: 100-265V AC 50/60Hz  
 CRI:>80  
 Die casting Aluminum  
 Class: I  
 Color: Silver Grey/Dark Grey/Black/White

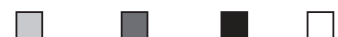

Dimension: 3W/105x60x60mm, 6W/ 210x65x60mm

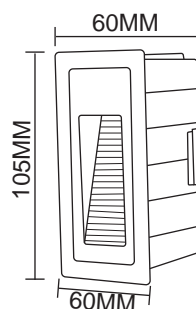
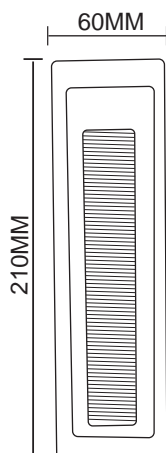

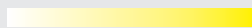

6000K 5000K 4000K 3000K 2700K

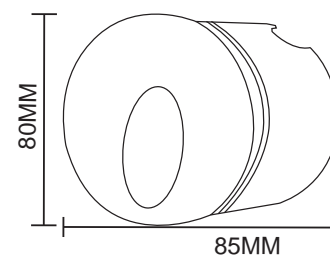
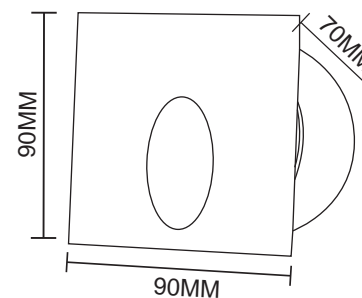
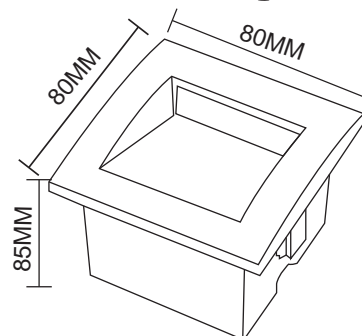
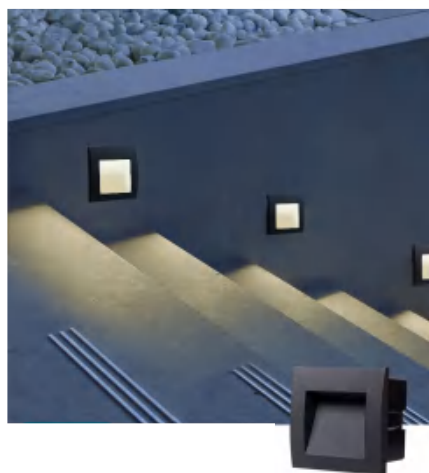
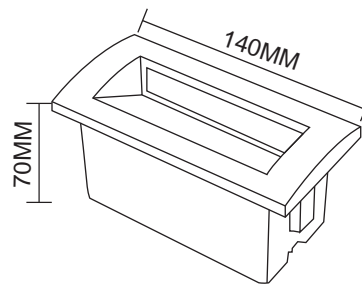

ST084, ST085, ST086, ST087 Name:  
 Outdoor LED 3W Wall Light Power: 3W  
 Input voltage: 100-265V AC 50/60Hz  
 CRI:>80  
 Die casting Aluminum  
 Class: I  
 Color: Silver Grey/Dark Grey/Black/White

Dimension: ST084 Ø80\*85MM

ST085 80\*80\*85MM

ST086 90\*90\*70MM

ST086 140\*70MM



# 05

Outdoor LED Wall Light





6000K 5000K 4000K 3000K 2700K



WL0111  
 Name: Outdoor LED COB 3W/GU10 Wall Light  
 Power: 3W/GU10  
 Input voltage: 100-265V AC 50/60Hz  
 CRI:>80  
 Die casting Aluminum  
 Class: I  
 Color: Silver Grey/Dark Grey/Black/White

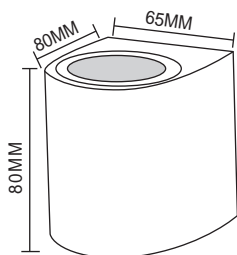

Dimension: 65x80x80mm



WL0110  
 Name: Outdoor LED COB 2x 3W/GU10 Up and Down Wall Light  
 Power: 2x3W/GU10  
 Input voltage: 100-265V AC 50/60Hz  
 CRI:>80  
 Die casting Aluminum  
 Class: I  
 Color: Silver Grey/Dark Grey/Black/White

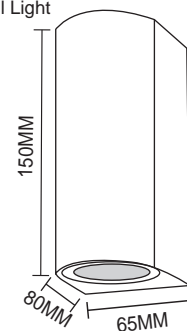

Dimension: 65x80x150mm

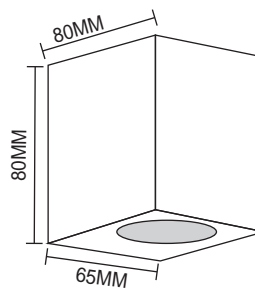
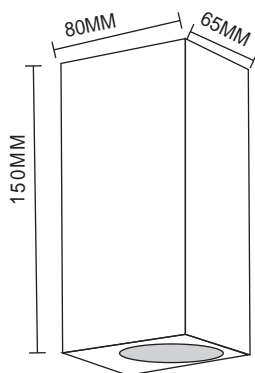

WL0112  
 Name: Outdoor LED COB 2x 3W/GU10 Up and Down Wall Light  
 Power: 2x3W/GU10  
 Input voltage: 100-265V AC 50/60Hz  
 CRI:>80  
 Die casting Aluminum  
 Class: I  
 Color: Silver Grey/Dark Grey/Black/White



Dimension: 65x80x150mm



WL0111  
 Name: Outdoor LED COB 3W/GU10 Wall Light  
 Power: 3W/GU10  
 Input voltage: 100-265V AC 50/60Hz  
 CRI:>80  
 Die casting Aluminum  
 Class: I  
 Color: Silver Grey/Dark Grey/Black/White



Dimension: 65x80x80mm



● 6000K ● 5000K ● 4000K ● 3000K ● 2700K

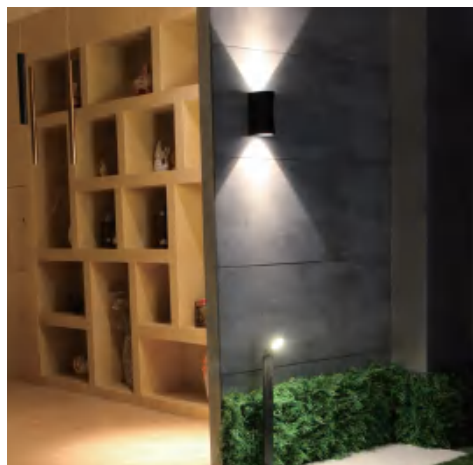

WL0116  
Name: Outdoor LED COB 2x7W Wall Light  
Power: 2x7W  
Input voltage: 100-265V AC 50/60Hz  
CRI:>80  
Die casting Aluminum  
Class: I  
Color: Silver Grey/Dark Grey/Black/White

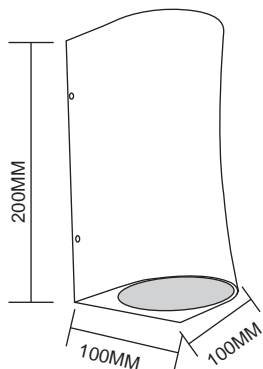

Dimension: 200x100x100mm



WL0114, WL0115  
Name: Outdoor LED COB 1x7W/ 2x7W Wall Light  
Power: 1x7W/ 2x7W  
Input voltage: 100-265V AC 50/60Hz  
CRI:>80  
Die casting Aluminum  
Class: I  
Color: Silver Grey/Dark Grey/Black/White

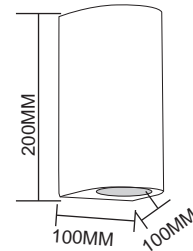
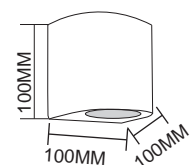

Dimension: 1X7W/100x100x100mm, 2x7W/200x100x100mm



WL0117  
Name: Outdoor LED COB 2x7W Wall Light  
Power: 2x7W  
Input voltage: 100-265V AC 50/60Hz  
CRI:>80  
Die casting Aluminum  
Class: I  
Color: Silver Grey/Dark Grey/Black/White

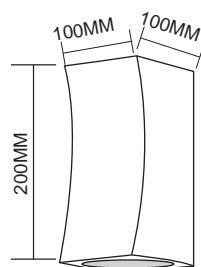

Dimension: 200x100x100mm



WL5110, WL5111, WL5112, WL5113  
Name: Outdoor LED 2x3W, 2x6W, 2X10W, 2X12W Wall Light  
Power: 2x3W, 2x6W, 2X10W, 2X12W  
Input voltage: 100-265V AC 50/60Hz  
CRI:>80  
Die casting Aluminum  
Class: I  
Color: Silver Grey/Dark Grey/Black/White

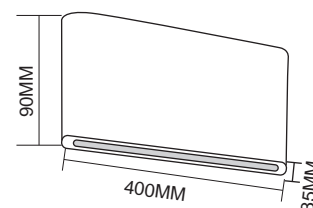

Dimension:  
2x3W, 115x90x35mm  
2x6W, 175x90x35mm  
2X10W, 300x90x35mm  
2X12W, 400x90x35mm





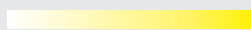

6000K 5000K 4000K 3000K 2700K



WL5116, WL5117, WL5112, WL5113  
 Name: Outdoor LED 2x3W,4x3W, 6x3W, 8x3W,10x3W,12x3W Wall Light  
 Power: 2x3W,4x3W, 6x3W, 8x3W,10x3W,12x3W  
 Input voltage: 100-265V AC 50/60Hz  
 CRI:>80  
 Die casting Aluminum  
 Class: I  
 Color: Silver Grey/Dark Grey/Black/White



Dimension:  
 2x3W,80x70x36mm  
 4x3W, 120x92x38mm  
 6x3W, 185x95x40mm  
 8x3W, 220x95x50mm  
 10x3W, 230x95x38mm  
 12x3W, 300x95x38mm

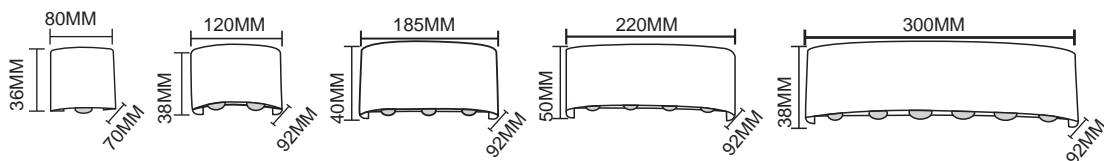

WL601  
 Name: Outdoor LED 10W Wall Light  
 Power:10W  
 Input voltage: 100-265V AC 50/60Hz  
 CRI:>80  
 Die casting Aluminum  
 Class: I  
 Color: Silver Grey/Dark Grey/Black/White



Dimension: 130x100x230mm

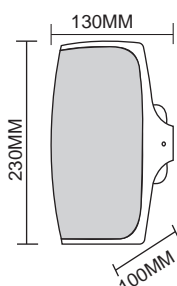

WL5185  
 Name: Outdoor LED 1X10W Wall Light  
 Power: 1X10W  
 Input voltage: 100-265V AC 50/60Hz  
 CRI:>80  
 Die casting Aluminum  
 Class: I  
 Color: Silver Grey/Dark Grey/Black/White



Dimension: 400x130x283mm

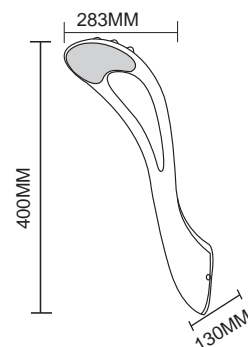

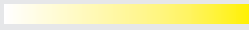

6000K 5000K 4000K 3000K 2700K

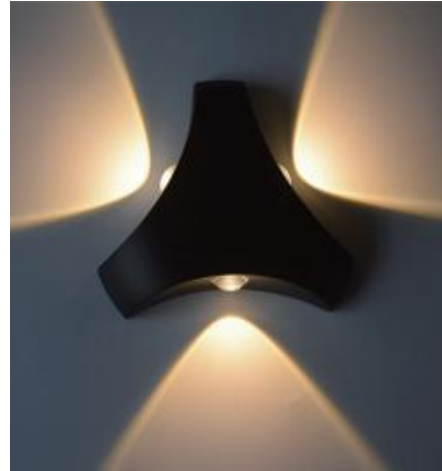

WL5180  
 Name: Outdoor LED 1X10W Wall Light  
 Power: 1X10W  
 Input voltage: 100-265V AC 50/60Hz  
 CRI:>80  
 Die casting Aluminum  
 Class: I  
 Color: Silver Grey/Dark Grey/Black/White



Dimension: 170x100x192mm

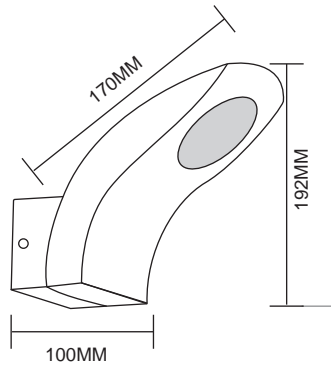

WL3015  
 Name: Outdoor LED 3x3W Side Emitting Wall Light  
 Power: 3x3W  
 Input voltage: 100-265V AC 50/60Hz  
 CRI:>80  
 Die casting Aluminum  
 Class: I  
 Color: Silver Grey/Dark Grey/Black/White



Dimension: 205x160x45mm

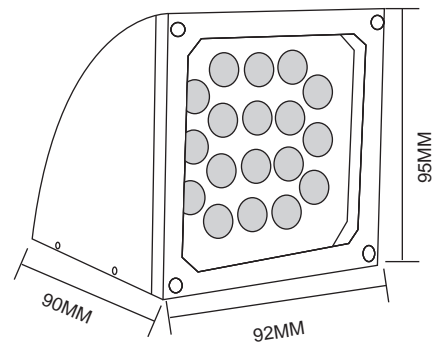
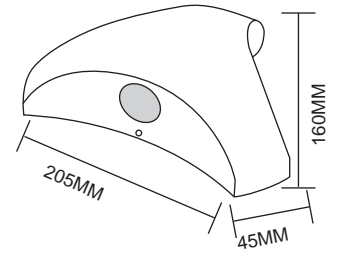

WL0120, WL0121, WL0122  
 Name: Outdoor LED 5W/10W/15W Wall Light  
 Power: 5W/10W/15W  
 Input voltage: 100-265V AC 50/60Hz  
 CRI:>80  
 Die casting Aluminum  
 Class: I  
 Color: Silver Grey/Dark Grey/Black/White



Dimension: 5w/92x95x90mm, 10W/120x125x120mm, 15W/155x150x145mm



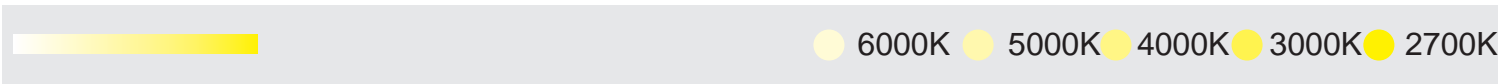

WL2020  
 Name: Outdoor LED 1x6W / 2x6W Wall Light  
 Power: 1x6W / 2x6W Wall Light  
 Input voltage: 100-265V AC 50/60Hz  
 CRI:>80  
 Die casting Aluminum  
 Class: I  
 Color: Silver Grey/Dark Grey/Black/White

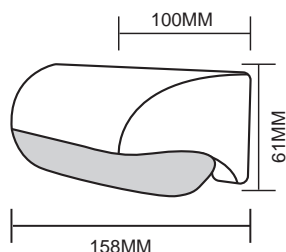

Dimension: 158x61x100mm



WL2021  
 Name: Outdoor LED 1x10W / 2x10W Wall Light  
 Power: 1x10W / 2x10W Wall Light  
 Input voltage: 100-265V AC 50/60Hz  
 CRI:>80  
 Die casting Aluminum  
 Class: I  
 Color: Silver Grey/Dark Grey/Black/White

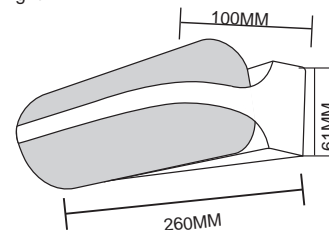

Dimension: 260x61x100mm

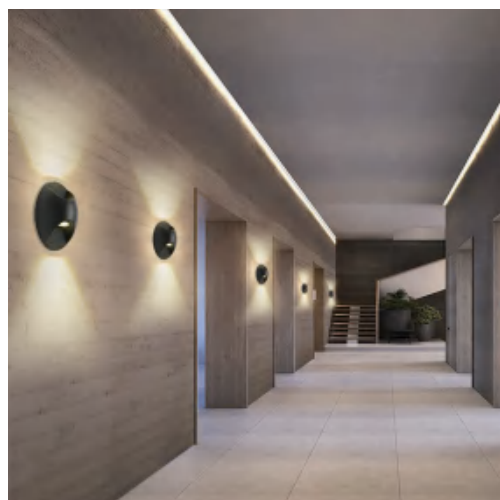

WL0126  
 Name: Outdoor LED 2X3W Wall Light  
 Power: 2X3W  
 Input voltage: 100-265V AC 50/60Hz  
 CRI:>80  
 Die casting Aluminum  
 Class: I  
 Color: Silver Grey/Dark Grey/Black/White

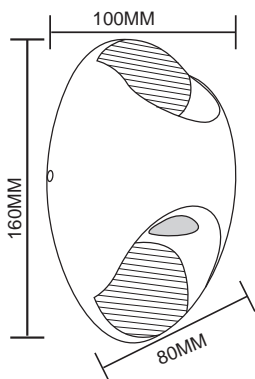

Dimension: 100x80x160mm



WL0127  
 Name: Outdoor LED 1X3W Wall Light  
 Power: 1X3W  
 Input voltage: 100-265V AC 50/60Hz  
 CRI:>80  
 Die casting Aluminum  
 Class: I  
 Color: Silver Grey/Dark Grey/Black/White

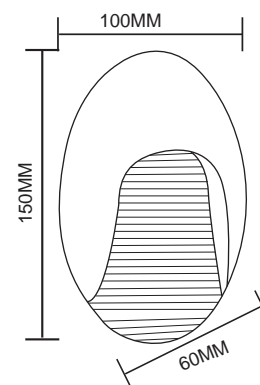

Dimension: 100x60x150mm



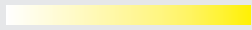

● 6000K ● 5000K ● 4000K ● 3000K ● 2700K

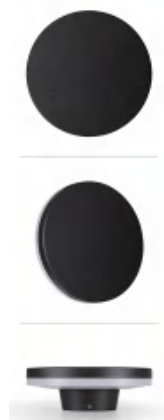

WL5051  
 Name: Outdoor LED 12W Wall Light  
 Power: 12W Wall Light  
 Input voltage: 100-265V AC 50/60Hz  
 CRI:>80  
 Die casting Aluminum  
 Class: I  
 Color: Silver Grey/Dark Grey/Black/White



Dimension: Ø150xH50mm

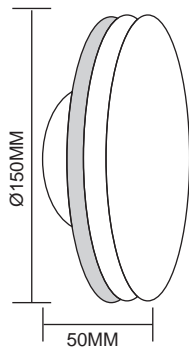

WL5052  
 Name: Outdoor LED 12W Wall Light  
 Power: 12W Wall Light  
 Input voltage: 100-265V AC 50/60Hz  
 CRI:>80  
 Die casting Aluminum  
 Class: I  
 Color: Silver Grey/Dark Grey/Black/White



Dimension: 150x150XH50mm

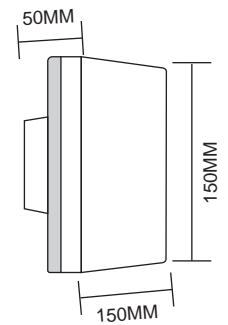

WL5053  
 Name: Outdoor LED 20W Wall Light  
 Power: 20W Wall Light  
 Input voltage: 100-265V AC 50/60Hz  
 CRI:>80  
 Die casting Aluminum  
 Class: I  
 Color: Silver Grey/Dark Grey/Black/White



Dimension: 200x160X45mm

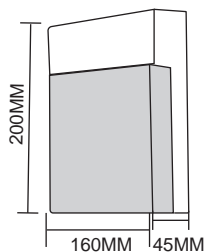

WL2019  
 Name: Outdoor LED 1x7W /2x7W Wall Light  
 Power: 1x7W /2x7W Wall Light  
 Input voltage: 100-265V AC 50/60Hz  
 CRI:>80  
 Die casting Aluminum  
 Class: I  
 Color: Silver Grey/Dark Grey/Black/White



Dimension: 148x130x65mm

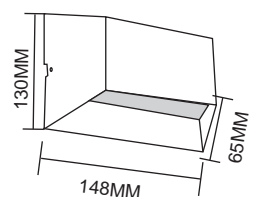



6000K

5000K

4000K

3000K

2700K

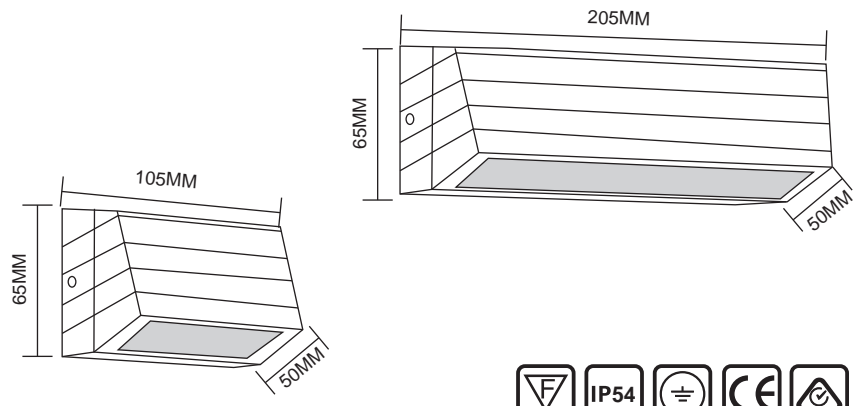

ST693, 694  
 Name: Outdoor LED 6W /12W Wall Light  
 Power: 6W /12W  
 Input voltage: 100-265V AC 50/60Hz  
 CRI:>80  
 Die casting Aluminum  
 Class: I  
 Color: Silver Grey/Dark Grey/Black/White



Dimension: 6W/105X65X60mm, 12W/205X65X50mm



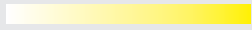

6000K 5000K 4000K 3000K 2700K

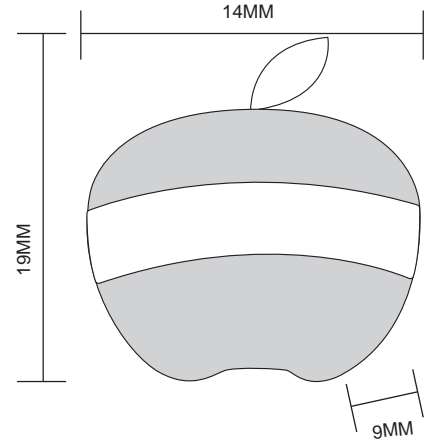

WL8803  
 Name: Outdoor LED 12W Wall Light  
 Power: 12W  
 Input voltage: 100-265V AC 50/60Hz  
 CRI:>80  
 Die casting Aluminum  
 Class: I  
 Color: Silver Grey/Dark Grey/Black/White



Dimension: 16x9x14mm

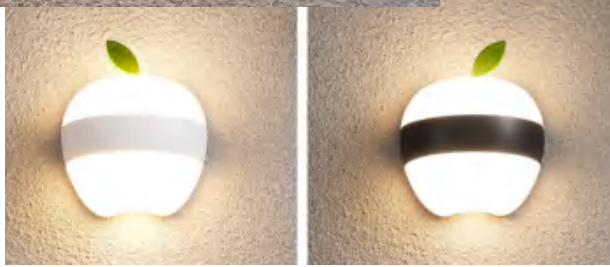

WL8805, WL8806, WL8807,  
 Name: Outdoor LED 12W/18W/24W Wall Light  
 Power: 12W/18W/24W  
 Input voltage: 100-265V AC 50/60Hz  
 CRI:>80  
 Die casting Aluminum  
 Class: I  
 Color: Silver Grey/Dark Grey/Black/White



Dimension: 12W/70x65x155mm  
 18W/70x65x220mm  
 24W/70x65x370mm

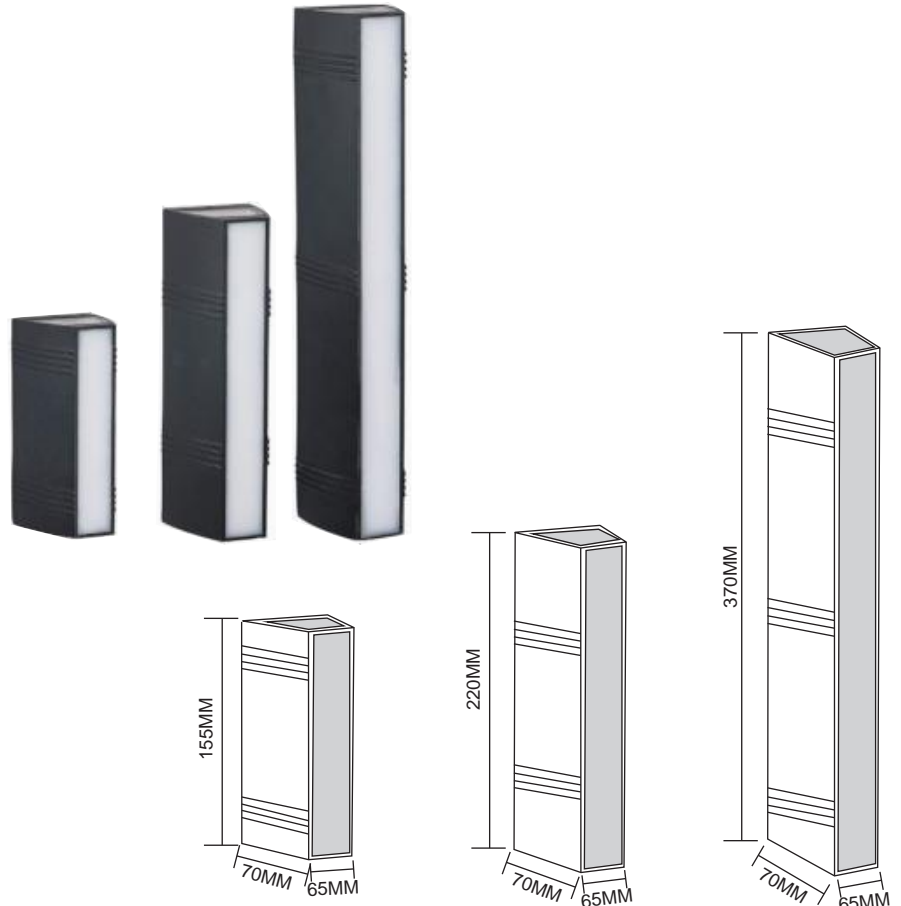

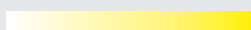

6000K 5000K 4000K 3000K 2700K



WL3001  
 Name: Outdoor LED 10W Wall Light  
 Power: 10W Wall Light  
 Input voltage: 100-265V AC 50/60Hz  
 CRI:>80  
 Die casting Aluminum  
 Class: I  
 Color: Silver Grey/Dark Grey/Black/White



Dimension: 192x97x75mm

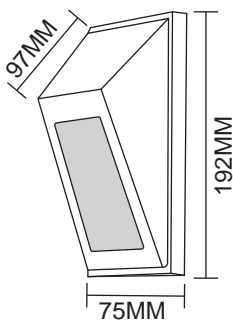

WL3002  
 Name: Outdoor LED 5W Wall Light  
 Power: 5W Wall Light  
 Input voltage: 100-265V AC 50/60Hz  
 CRI:>80  
 Die casting Aluminum  
 Class: I  
 Color: Silver Grey/Dark Grey/Black/White



Dimension: 132x89x78mm

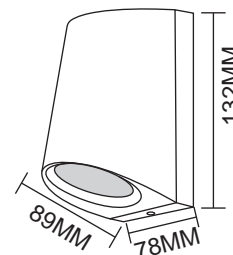

WL8003  
 Name: Outdoor LED 3W Wall Light  
 Power: 3W Wall Light  
 Input voltage: 100-265V AC 50/60Hz  
 CRI:>80  
 Die casting Aluminum  
 Class: I  
 Color: Silver Grey/Dark Grey/Black/White



Dimension: 256x128x50mm

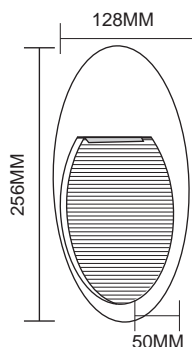

WL8004  
 Name: Outdoor LED 3W Wall Light  
 Power: 3W Wall Light  
 Input voltage: 100-265V AC 50/60Hz  
 CRI:>80  
 Die casting Aluminum  
 Class: I  
 Color: Silver Grey/Dark Grey/Black/White



Dimension: 256x128x50mm

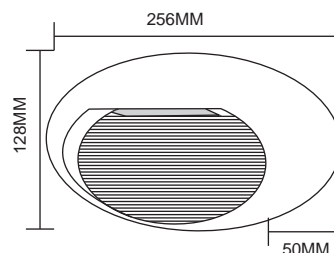

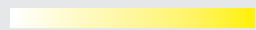

6000K 5000K 4000K 3000K 2700K



WL2011  
 Name: Outdoor LED 2x6W Wall Light  
 Power: 2x6W  
 Input voltage: 100-265V AC 50/60Hz  
 CRI:>80  
 Die casting Aluminum  
 Class: I  
 Color: Silver Grey/Dark Grey/Black/White



Dimension: 160x90x35mm

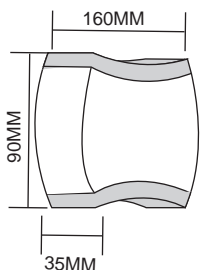

WL2012  
 Name: Outdoor LED 2x6W Wall Light  
 Power: 12x6W Wall Light  
 Input voltage: 100-265V AC 50/60Hz  
 CRI:>80  
 Die casting Aluminum  
 Class: I  
 Color: Silver Grey/Dark Grey/Black/White



Dimension: Ø160x35mm

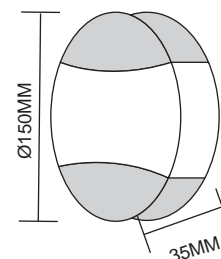

WL2017  
 Name: Outdoor LED 18W Wall Light  
 Power: 18W Wall Light  
 Input voltage: 100-265V AC 50/60Hz  
 CRI:>80  
 Die casting Aluminum  
 Class: I  
 Color: Silver Grey/Dark Grey/Black/White



Dimension: Ø200x45mm

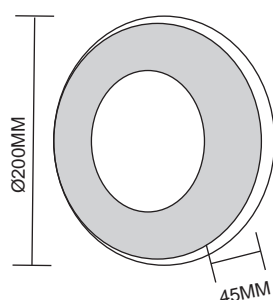

WL2018  
 Name: Outdoor LED 18W Wall Light  
 Power: 18W Wall Light  
 Input voltage: 100-265V AC 50/60Hz  
 CRI:>80  
 Die casting Aluminum  
 Class: I  
 Color: Silver Grey/Dark Grey/Black/White



Dimension: 200x200x45mm

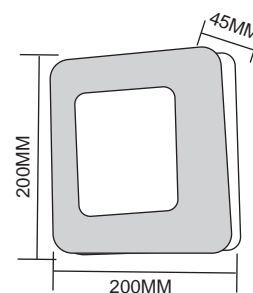



6000K 5000K 4000K 3000K 2700K



WL0124  
Name: Outdoor LED COB 5W Wall Light  
Power: 5W  
Input voltage: 100-265V AC 50/60Hz  
CRI:>80  
Die casting Aluminum  
Class: I  
Color: Silver Grey/Dark Grey/Black/White

Dimension: 100x65x65mm

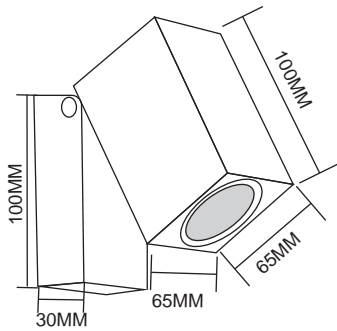

WL0125  
Name: Outdoor LED 2X3W Wall Light  
Power: 2X3W  
Input voltage: 100-265V AC 50/60Hz  
CRI:>80  
Die casting Aluminum  
Class: I  
Color: Silver Grey/Dark Grey/Black/White

Dimension: 55x85x170mm

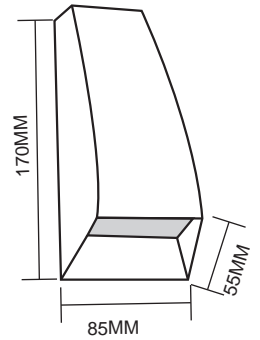

WL0128  
Name: Outdoor LED 10W/24W Wall Light  
Power: 10W/24W  
Input voltage: 100-265V AC 50/60Hz  
CRI:>80  
Die casting Aluminum  
Class: I  
Color: Silver Grey/Dark Grey/Black/White

Dimension: 300x95x110mm

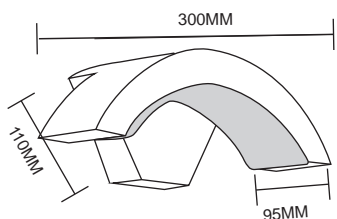

WL0128P  
Name: Outdoor LED 10W/24W Wall Light  
Power: 10W/24W  
Input voltage: 100-265V AC 50/60Hz  
CRI:>80  
Die casting Aluminum  
Class: I  
Color: Silver Grey/Dark Grey/Black/White

Dimension: 300x95x110mm Pole: H600mm

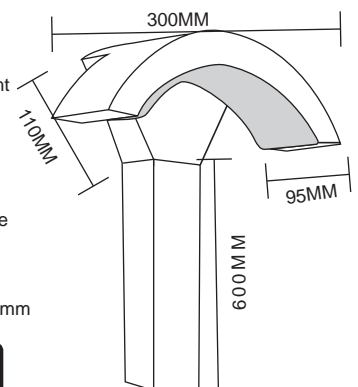

● 6000K ● 5000K ● 4000K ● 3000K ● 2700K

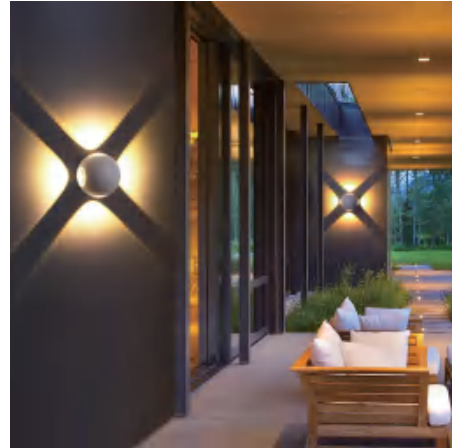

WL0120, WL0121  
 Name: Outdoor LED COB 2x3W Wall Light  
 Power: 2x3W  
 Input voltage: 100-265V AC 50/60Hz  
 CRI:>80  
 Die casting Aluminum  
 Class: I  
 Color: Silver Grey/Dark Grey/Black/White



Dimension: 165x95x55mm

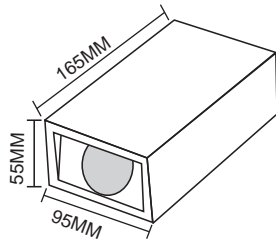

WL2881, WL2882, WL2883, WL2884  
 Name: Outdoor LED, 1x3W 2x3W, 3x3W, 4x3W Wall Light  
 Power: 1x3W 2x3W, 3x3W, 4x3W  
 Input voltage: 100-265V AC 50/60Hz  
 CRI:>80  
 Die casting Aluminum  
 Class: I  
 Color: Silver Grey/Dark Grey/Black/White



Dimension: Ø95mm

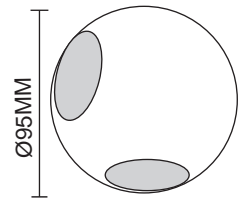

WL6014, WL6015  
 Name: Outdoor LED 6W /12W Wall Light  
 Power:6W /12W  
 Input voltage: 100-265V AC 50/60Hz  
 CRI:>80  
 Die casting Aluminum  
 Class: I  
 Color: Silver Grey/Dark Grey/Black/White



Dimension: 6W/Ø117x33mm, 12W/Ø200x33mm

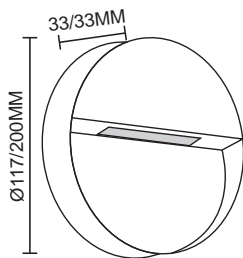

WL6016, WL6017  
 Name: Outdoor LED 6W /12W Wall Light  
 Power:6W /12W  
 Input voltage: 100-265V AC 50/60Hz  
 CRI:>80  
 Die casting Aluminum  
 Class: I  
 Color: Silver Grey/Dark Grey/Black/White



Dimension: 6W/117x117x33mm, 12W/200x200x33mm

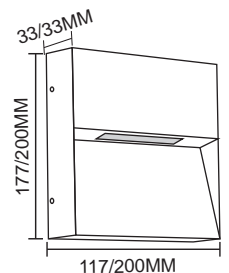

6000K 5000K 4000K 3000K 2700K

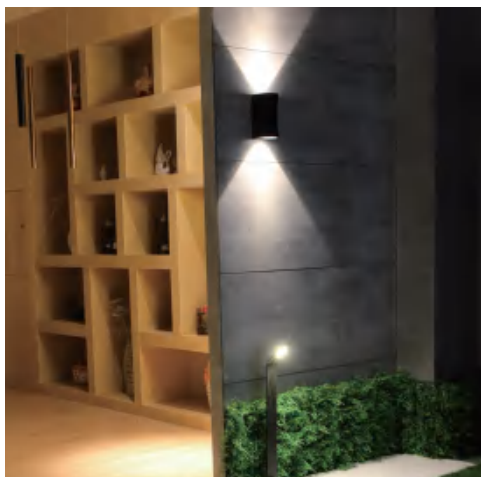

WL0116  
Name: Outdoor LED COB 2x7W Wall Light  
Power: 2x7W  
Input voltage: 100-265V AC 50/60Hz  
CRI:>80  
Die casting Aluminum  
Class: I  
Color: Silver Grey/Dark Grey/Black/White



Dimension: 200x100x100mm

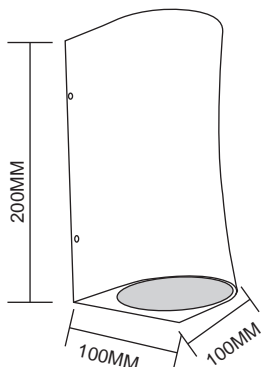

WL0114, WL0115  
Name: Outdoor LED COB 1x7W/ 2x7W Wall Light  
Power: 1x7W/ 2x7W  
Input voltage: 100-265V AC 50/60Hz  
CRI:>80  
Die casting Aluminum  
Class: I  
Color: Silver Grey/Dark Grey/Black/White



Dimension: 1X7W/100x100x100mm, 2x7W/200x100x100mm

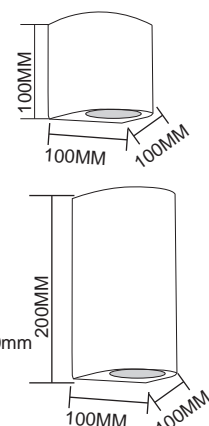

WL0117  
Name: Outdoor LED COB 2x7W Wall Light  
Power: 2x7W  
Input voltage: 100-265V AC 50/60Hz  
CRI:>80  
Die casting Aluminum  
Class: I  
Color: Silver Grey/Dark Grey/Black/White



Dimension: 200x100x100mm

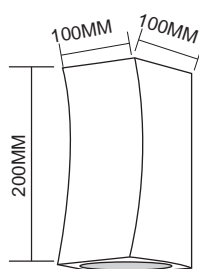

WL5110, WL5111, WL5112, WL5113  
Name: Outdoor LED 2x3W, 2x6W, 2X10W, 2X12W Wall Light  
Power: 2x3W, 2x6W, 2X10W, 2X12W  
Input voltage: 100-265V AC 50/60Hz  
CRI:>80  
Die casting Aluminum  
Class: I  
Color: Silver Grey/Dark Grey/Black/White

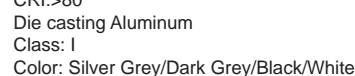

Dimension:  
2x3W, 115x90x35mm  
2x6W, 175x90x35mm  
2X10W, 300x90x35mm  
2X12W, 400x90x35mm

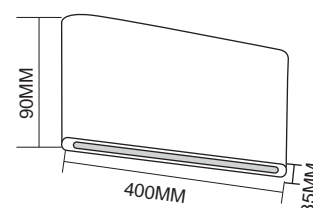

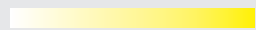

6000K 5000K 4000K 3000K 2700K

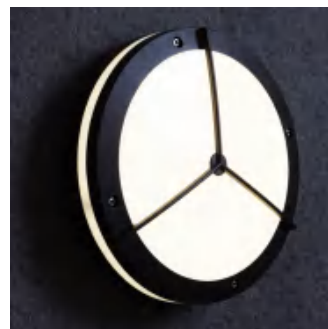

WL5016, 5017, 5018, 5019  
 Name: Outdoor LED 18W/E27 Wall Light  
 Power: 18W/ E27  
 Input voltage: 100-265V AC 50/60Hz  
 CRI:>80  
 Die casting Aluminum  
 Class: I  
 Color: Silver Grey/Dark Grey/Black/White

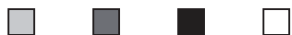

Dimension: Ø300mm

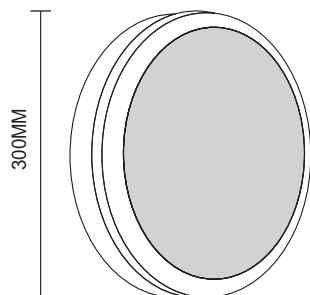

● 6000K ● 5000K ● 4000K ● 3000K ● 2700K



WL0715S, WL0715L  
 Name: Outdoor LED 10W/20W Wall Light  
 Power: 10W/ 20W  
 Input voltage: 100-265V AC 50/60Hz  
 CRI:>80  
 Die casting Aluminum  
 Class: I  
 Color: Silver Grey/Dark Grey/Black/White



Dimension: 10W/125X125X260mm, 20W/300x140x145mm

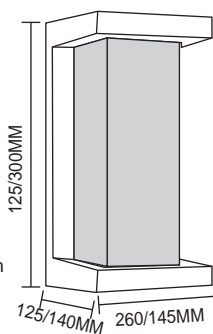

WL0716  
 Name: Outdoor LED 10W/E27 Wall Light  
 Power: 10W/ E27  
 Input voltage: 100-265V AC 50/60Hz  
 CRI:>80  
 Die casting Aluminum  
 Class: I  
 Color: Silver Grey/Dark Grey/Black/White



Dimension: 115x115x250mm

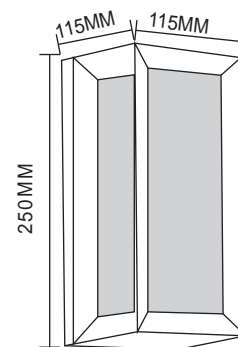

WL0717  
 Name: Outdoor LED 10W/20W/E27 Wall Light  
 Power: 10W/ 20W/E27  
 Input voltage: 100-265V AC 50/60Hz  
 CRI:>80  
 Die casting Aluminum  
 Class: I  
 Color: Silver Grey/Dark Grey/Black/White



Dimension: 10W/260X125X125mm, 20W/300x140x145mm

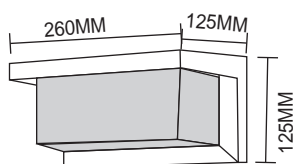

WL0718  
 Name: Outdoor LED 10W Wall Light  
 Power: 10W  
 Input voltage: 100-265V AC 50/60Hz  
 CRI:>80  
 Die casting Aluminum  
 Class: I  
 Color: Silver Grey/Dark Grey/Black/White



Dimension: 165x165x190mm

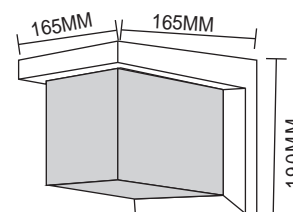

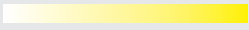

6000K 5000K 4000K 3000K 2700K



WL6011  
 Name: Outdoor LED 3W Wall Light  
 Power: 3x1W  
 Input voltage: 100-265V AC 50/60Hz  
 CRI:>80  
 Die casting Aluminum  
 Class: I  
 Color: Silver Grey/Dark Grey/Black/White



Dimension: 80x80x50mm

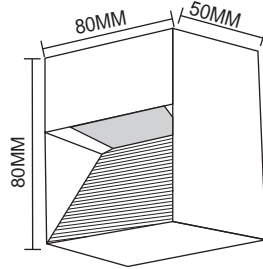

WL6012  
 Name: Outdoor LED 3W Wall Light  
 Power: 3x1W  
 Input voltage: 100-265V AC 50/60Hz  
 CRI:>80  
 Die casting Aluminum  
 Class: I  
 Color: Silver Grey/Dark Grey/Black/White



Dimension: Ø160x95mm

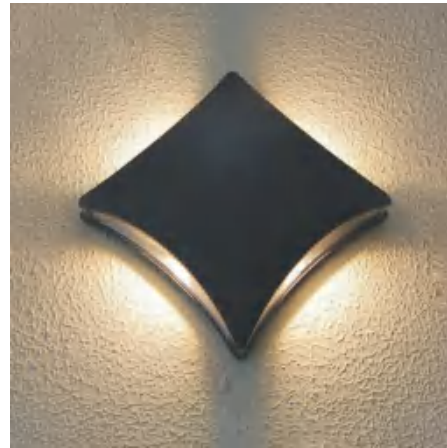
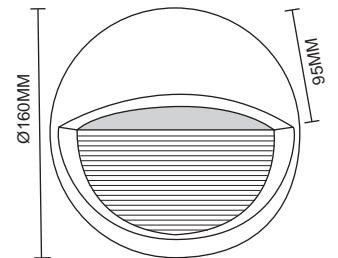

WL6013  
 Name: Outdoor LED 4W Wall Light  
 Power: 4x1W  
 Input voltage: 100-265V AC 50/60Hz  
 CRI:>80  
 Die casting Aluminum  
 Class: I  
 Color: Silver Grey/Dark Grey/Black/White



Dimension: 160x160x100mm

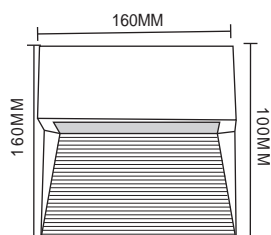

WL6019  
 Name: Outdoor LED 4x3W Wall Light  
 Power: 4x3W  
 Input voltage: 100-265V AC 50/60Hz  
 CRI:>80  
 Die casting Aluminum  
 Class: I  
 Color: Silver Grey/Dark Grey/Black/White



Dimension: 280x280x65mm

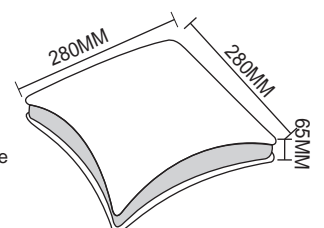

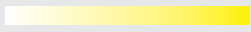

6000K 5000K 4000K 3000K 2700K

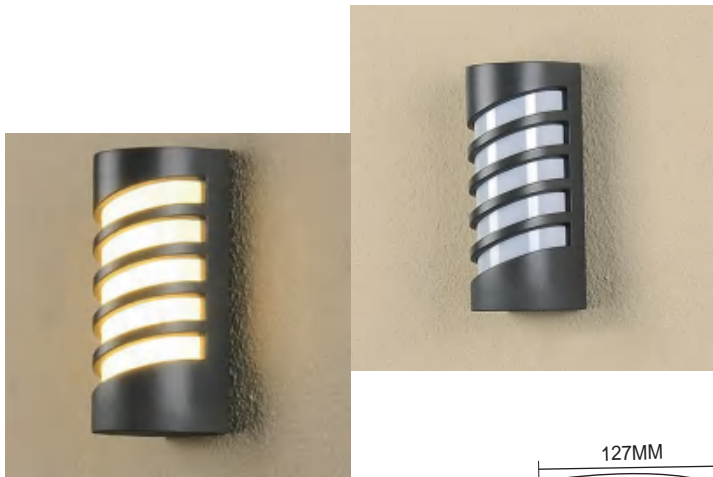

WL5055  
 Name: Outdoor LED 10W Wall Light  
 Power: 2x3W  
 Input voltage: 100-265V AC 50/60Hz  
 CRI:>80  
 Die casting Aluminum  
 Class: I  
 Color: Silver Grey/Dark Grey/Black/White



Dimension: 260x127x70mm

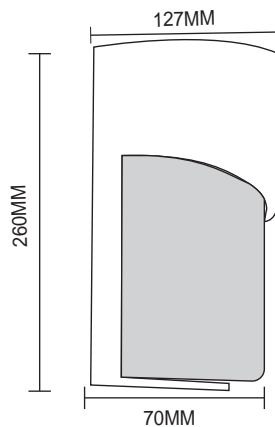

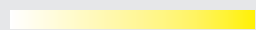

● 6000K ● 5000K ● 4000K ● 3000K ● 2700K



WL0863  
 Name: Outdoor LED 2x3W Wall Light  
 Power: 2x3W  
 Input voltage: 100-265V AC 50/60Hz  
 CRI:>80  
 Die casting Aluminum  
 Class: I  
 Color: Silver Grey/Dark Grey/Black/White



Dimension: 80x65x140mm

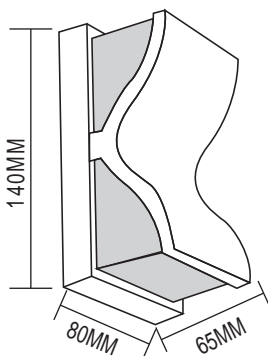

WL0861(1x3W), GA-WL0862(3X1W) Name:  
 Outdoor LED 1x3W/3x1W Wall Light Power:  
 1x3W/3x1W  
 Input voltage: 100-265V AC 50/60Hz  
 CRI:>80  
 Die casting Aluminum  
 Class: I  
 Color: Silver Grey/Dark Grey/Black/White



Dimension: GA-WL0441/80x80x65mm, GA-WL0442/80x90x140mm

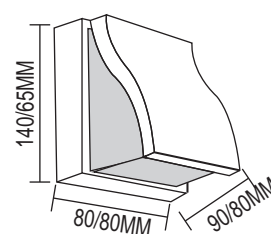

WL0618  
 Name: Outdoor LED 6W/12W/18W Wall Light  
 Power: 6W/12W/18W  
 Input voltage: 100-265V AC 50/60Hz  
 CRI:>80  
 Die casting Aluminum  
 Class: I  
 Color: Silver Grey/Dark Grey/Black/White



Dimension: 6W/155x88x55mm, 12W/215x115x70mm, 18W/ 160x260x80mm

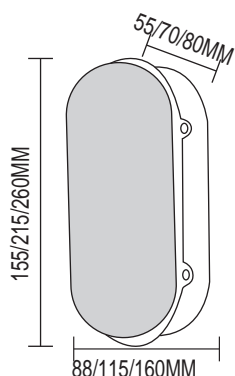

WL5078  
 Name: Outdoor LED 2x3W Wall Light  
 Power: 2x3W  
 Input voltage: 100-265V AC 50/60Hz  
 CRI:>80  
 Die casting Aluminum  
 Class: I  
 Color: Silver Grey/Dark Grey/Black/White



Dimension: 140X80X65mm

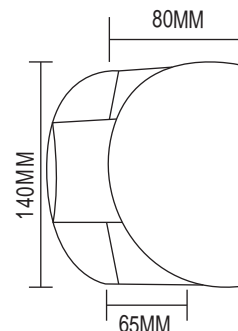



6000K 5000K 4000K 3000K 2700K

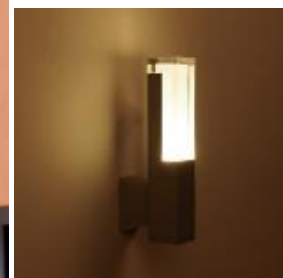
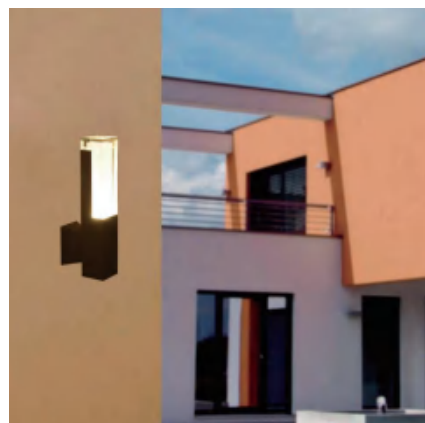

WL1900-1  
 Name: Outdoor LED 3W Up and Down Wall Light  
 Power: 3W  
 Input voltage: 100-265V AC 50/60Hz  
 CRI:>80  
 Die casting Aluminum  
 Class: I  
 Color: Silver Grey/Dark Grey/Black/White

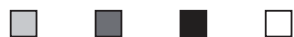

Dimension: 65x65x280mm

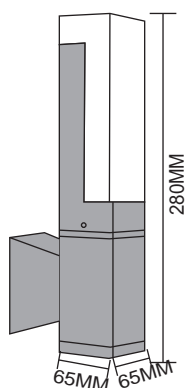

WL1900-2  
 Name: Outdoor LED 2x3W Up and Down Wall Light  
 Power: 2x3W  
 Input voltage: 100-265V AC 50/60Hz  
 CRI:>80  
 Die casting Aluminum  
 Class: I  
 Color: Silver Grey/Dark Grey/Black/White

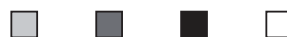

Dimension: 65x65x350mm

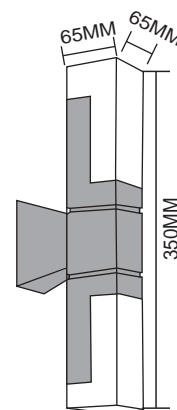

Name: Outdoor LED 2x3W Up and Down Wall Light  
 WL8005F  
 Power: 2x3W  
 Input voltage: 100-265V AC 50/60Hz  
 CRI:>80  
 Die casting Aluminum  
 Class: I  
 Color: Silver Grey/Dark Grey/Black/White

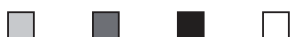

Dimension: 100x100x100mm

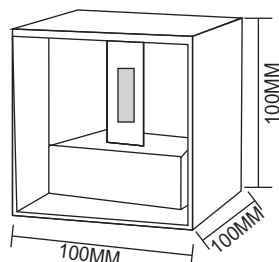

WL8005Y  
 Name: Outdoor LED 2x3W Up and Down Wall Light  
 Power: 2x3W  
 Input voltage: 100-265V AC 50/60Hz  
 CRI:>80  
 Die casting Aluminum  
 Class: I  
 Color: Silver Grey/Dark Grey/Black/White



Dimension: 100x100x100mm

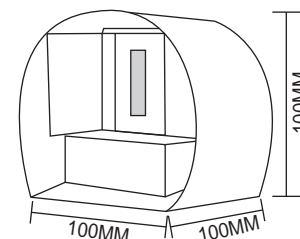

6000K 5000K 4000K 3000K 2700K



WL2105  
 Name: Outdoor LED 10W Wall Light  
 Power: 10W Wall Light  
 Input voltage: 100-265V AC 50/60Hz  
 CRI:>80  
 Die casting Aluminum  
 Class: I  
 Color: Silver Grey/Dark Grey/Black/White



Dimension: Ø145x60mm

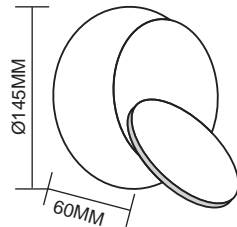

WL0126  
 Name: Outdoor LED 2X3W Wall Light  
 Power: 2X3W  
 Input voltage: 100-265V AC 50/60Hz  
 CRI:>80  
 Die casting Aluminum  
 Class: I  
 Color: Silver Grey/Dark Grey/Black/White



Dimension: 175x109x63mm

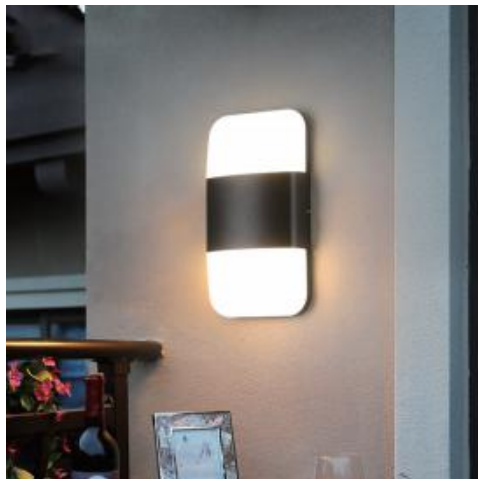
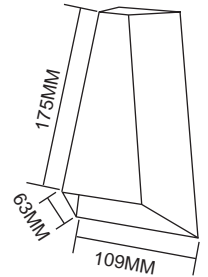

WL802  
 Name: Outdoor LED 2x7W Wall Light  
 Power:2x7W  
 Input voltage: 100-265V AC 50/60Hz  
 CRI:>80  
 Die casting Aluminum  
 Class: I  
 Color: Silver Grey/Dark Grey/Black/White



Dimension: 240x130x47mm

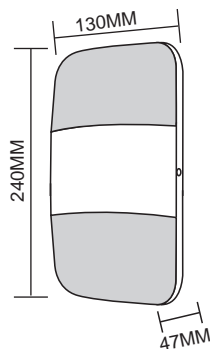

WL801  
 Name: Outdoor LED 1x7W Wall Light  
 Power:2x7W  
 Input voltage: 100-265V AC 50/60Hz  
 CRI:>80  
 Die casting Aluminum  
 Class: I  
 Color: Silver Grey/Dark Grey/Black/White



Dimension: 165x130x47mm

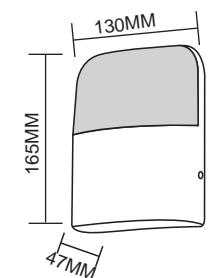

● 6000K ● 5000K ● 4000K ● 3000K ● 2700K

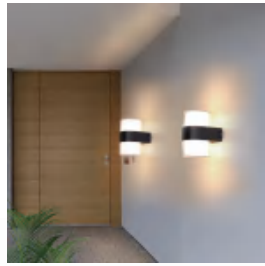

WL803, WL804  
 Name: Outdoor LED 7W /2x7W Wall Light  
 Power: 7W /2x7W  
 Input voltage: 100-265V AC 50/60Hz  
 CRI:>80  
 Die casting Aluminum  
 Class: I  
 Color: Silver Grey/Dark Grey/Black/White



Dimension: 7W/95x104x80mm, 2x7W/95x104x134mm

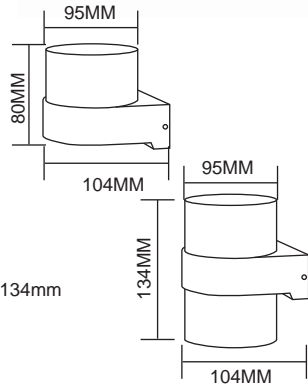

WL801, WL802  
 Name: Outdoor LED 7W /2x7W Wall Light  
 Power: 7W /2x7W  
 Input voltage: 100-265V AC 50/60Hz  
 CRI:>80  
 Die casting Aluminum  
 Class: I  
 Color: Silver Grey/Dark Grey/Black/White



Dimension: 7W/95x104x80mm, 2x7W/95x104x134mm

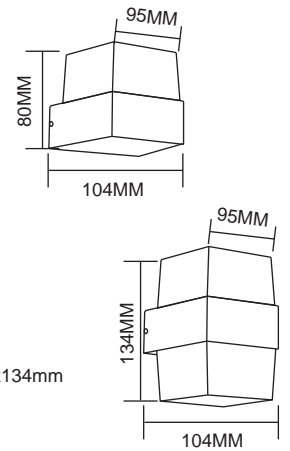

WL1170  
 Name: Outdoor LED COB 2x3W/2x10W/2x15W Wall Light  
 Power: 2x3W/2x10W/2x15W  
 Input voltage: 100-265V AC 50/60Hz  
 CRI:>80  
 Die casting Aluminum  
 Class: I  
 Color: Silver Grey/Dark Grey/Black/White



Dimension: 130/300/400mm

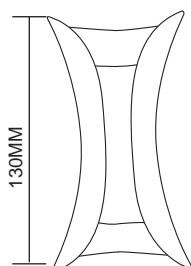

WL701, WL702, WL703, WL704  
 Name: Outdoor LED 18W Wall Light  
 Power: 18W  
 Input voltage: 100-265V AC 50/60Hz  
 CRI:>80  
 Die casting Aluminum  
 Class: I  
 Color: Silver Grey/Dark Grey/Black/White



Dimension: 198x160x59mm

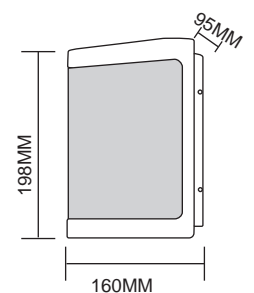

● 6000K ● 5000K ● 4000K ● 3000K ● 2700K



WL3007  
Name: Outdoor LED 1x3W Side Emitting Wall Light  
Power: 1x3W  
Input voltage: 100-265V AC 50/60Hz  
CRI:>80  
Die casting Aluminum  
Class: I  
Color: Silver Grey/Dark Grey/Black/White



Dimension: 80x80mm

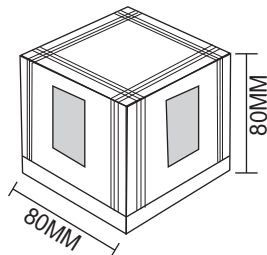

WL1008  
Name: Outdoor LED 2x3W Wall Light  
Power: 2x3W  
Input voltage: 100-265V AC 50/60Hz  
CRI:>80  
Die casting Aluminum  
Class: I  
Color: Silver Grey/Dark Grey/Black/White

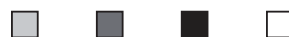

Dimension: 145x98x55mm

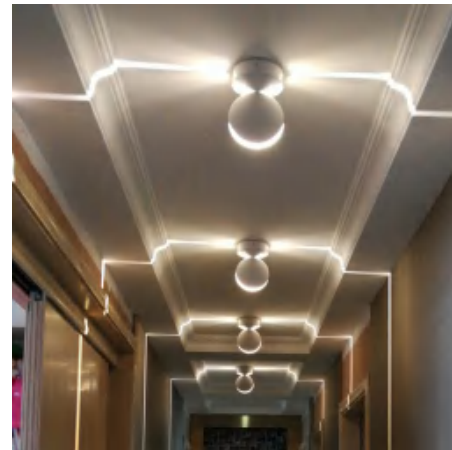
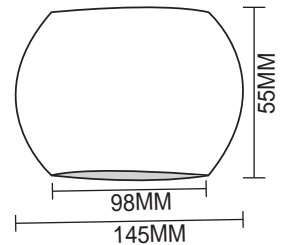

WL1047  
Name: Outdoor LED 2x3W Up and Down Wall Light  
Power: 2x3W/ GU10  
Input voltage: 100-265V AC 50/60Hz  
CRI:>80  
Die casting Aluminum  
Class: I  
Color: Silver Grey/Dark Grey/Black/White



Dimension: φ65x180mm

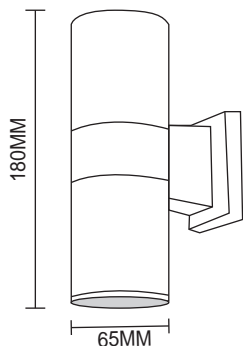

WL0708  
Name: Outdoor LED 10W Wall Light/Window trick light  
Power: 10W  
Input voltage: 100-265V AC 50/60Hz  
CRI:>80  
Die casting Aluminum  
Class: I  
Color: Silver Grey/Dark Grey/Black/White



Dimension: Ø120x170mm

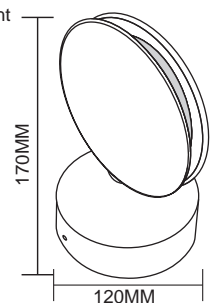

# 06



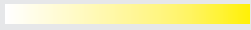

6000K 5000K 4000K 3000K 2700K



LD1207  
 Name: Outdoor LED 5W/10W/15W Lawn Light  
 Power: 5W/10W/15W  
 Input voltage: 100-265V AC 50/60Hz  
 CRI:>80  
 Die casting Aluminum  
 Class: I  
 Color: Silver Grey/Dark Grey/Black/White



Dimension: 5W/90x90mm, 10W/120x120mm, 15W/150x150mm  
 Height: 200/400/600/800mm

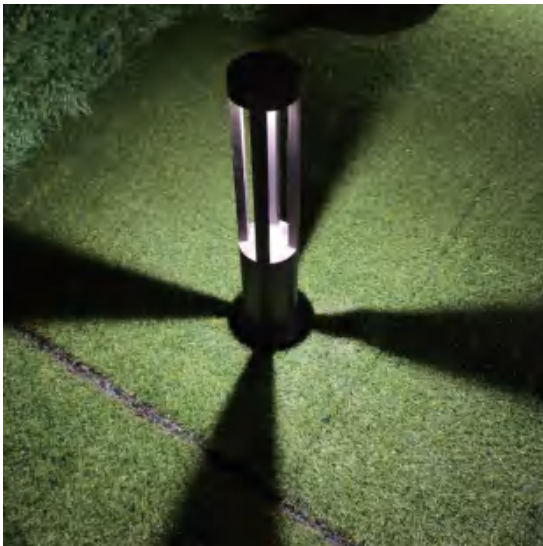
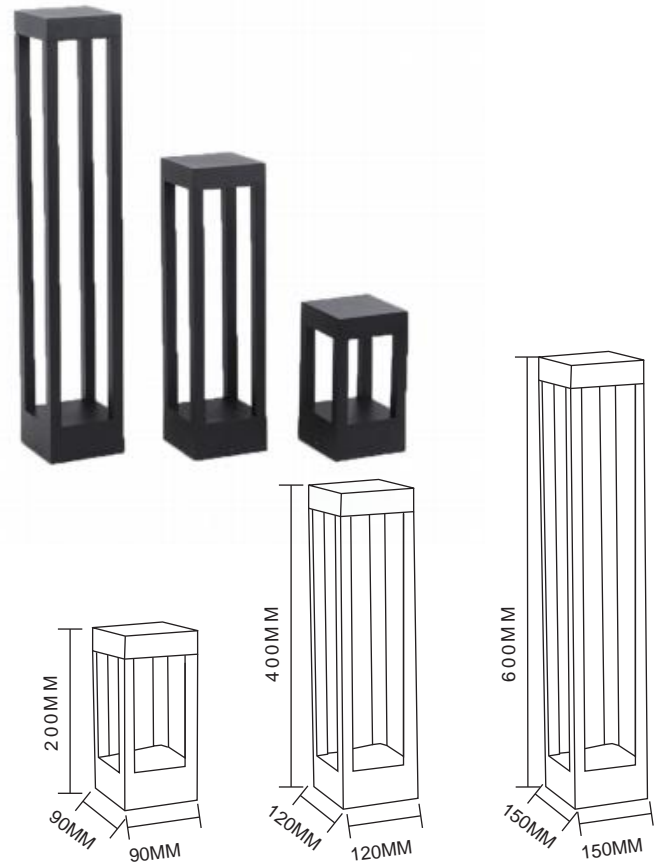

LD1208  
 Name: Outdoor LED 5W/10W/15W Lawn Light  
 Power: 5W/10W/15W  
 Input voltage: 100-265V AC 50/60Hz  
 CRI:>80  
 Die casting Aluminum  
 Class: I  
 Color: Silver Grey/Dark Grey/Black/White



Dimension: 5W/Ø90mm, 10W/Ø108mm, 15W/Ø145mm  
 Height: 400/600/800mm

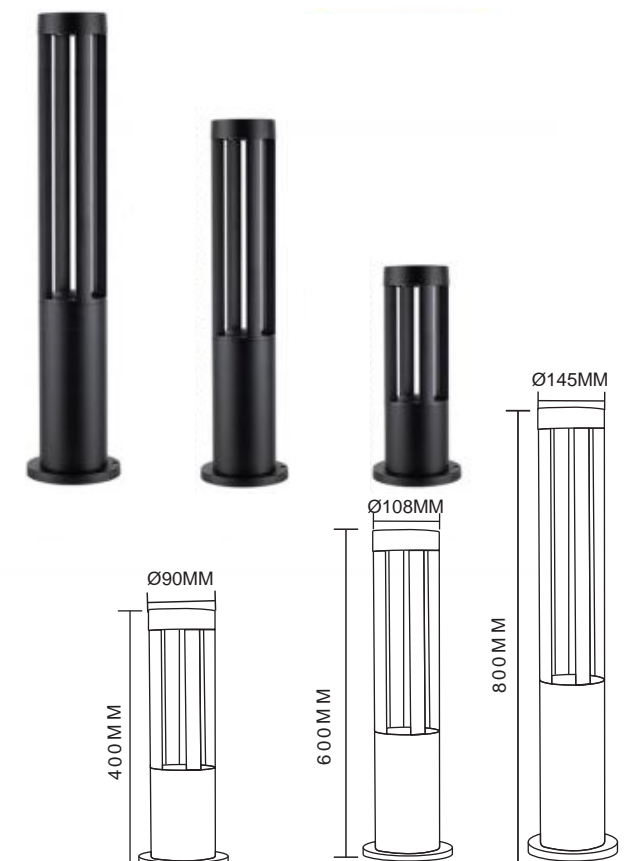

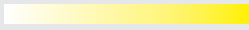

● 6000K ● 5000K ● 4000K ● 3000K ● 2700K



LD1201  
Name: Outdoor LED 10W Lawn Light  
Power: 10W  
Input voltage: 100-265V AC 50/60Hz  
CRI:>80  
Die casting Aluminum  
Class: I  
Color: Silver Grey/Dark Grey/Black/White



Dimension: 162X57mm  
Height: 200/400/600/800mm

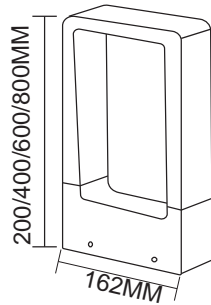

LD1201  
Name: Outdoor LED 10W Lawn Light  
Power: 10W  
Input voltage: 100-265V AC 50/60Hz  
CRI:>80  
Die casting Aluminum  
Class: I  
Color: Silver Grey/Dark Grey/Black/White



Dimension: 162X57mm  
Height: 200/400/600/800mm

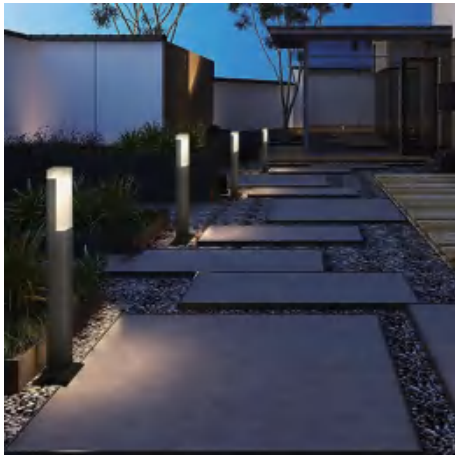
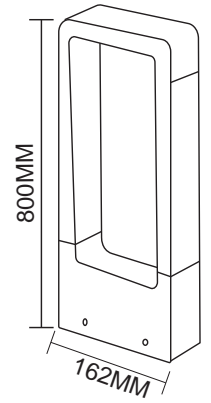

LD1205  
Name: Outdoor LED 3W Lawn Light  
Power: 3W  
Input voltage: 100-265V AC 50/60Hz  
CRI:>80  
Die casting Aluminum  
Class: I  
Color: Silver Grey/Dark Grey/Black/White



Dimension: 65x65x600mm

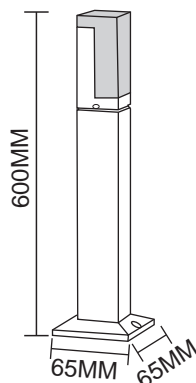

LD1206  
Name: Outdoor LED 5W/10W/15W Lawn Light  
Power: 5W/10W/15W  
Input voltage: 100-265V AC 50/60Hz  
CRI:>80  
Die casting Aluminum  
Class: I  
Color: Silver Grey/Dark Grey/Black/White

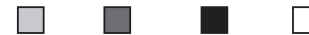

Dimension: 5W/Ø90mm, 10W/Ø108mm, 15W/Ø145mm  
Height: 200/400/600/800mm

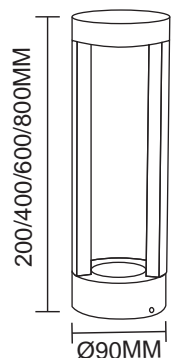

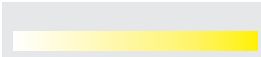

● 6000K ● 5000K ● 4000K ● 3000K ● 2700K



LD1209  
 Name: Outdoor LED 10W Lawn Light  
 Power: 10W  
 Input voltage: 100-265V AC 50/60Hz  
 CRI:>80  
 Die casting Aluminum  
 Class: I  
 Color: Silver Grey/Dark Grey/Black/White



Dimension:190x900mm

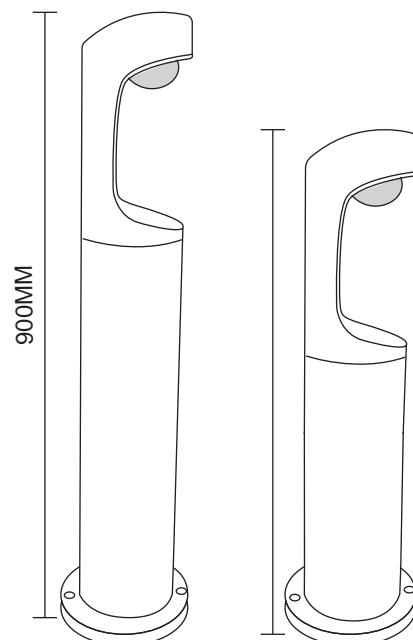



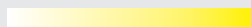

6000K 5000K 4000K 3000K 2700K



BL1001, BL1002  
 Name: Outdoor LED 7W/12W Bollard Light  
 Power: 7W/12W  
 Input voltage: 100-265V AC 50/60Hz  
 CRI: >80  
 Die casting Aluminum  
 Class: I  
 Color: Silver Grey/Dark Grey/Black/White



Dimension: 7W/Ø133x100mm, 12W/Ø160x130mm

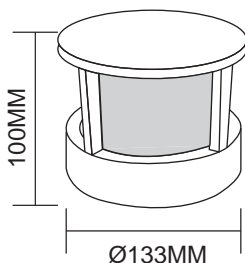

BL1003, BL1004  
 Name: Outdoor LED 7W/12W Bollard Light  
 Power: 7W/12W  
 Input voltage: 100-265V AC 50/60Hz  
 CRI: >80  
 Die casting Aluminum  
 Class: I  
 Color: Silver Grey/Dark Grey/Black/White



Dimension: 7W/Ø133x90mm, 12W/Ø160x120mm

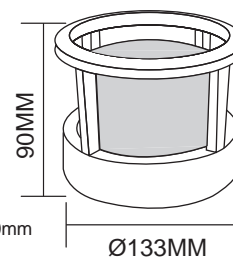

BL1005, BL1006  
 Name: Outdoor LED 7W/12W Bollard Light  
 Power: 7W/12W  
 Input voltage: 100-265V AC 50/60Hz  
 CRI: >80  
 Die casting Aluminum  
 Class: I  
 Color: Silver Grey/Dark Grey/Black/White



Dimension: 7W/133x133x100mm, 12W/160x160x130mm

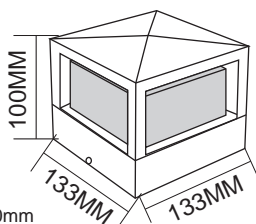

BL1007, BL1008  
 Name: Outdoor LED 7W/12W Bollard Light  
 Power: 7W/12W  
 Input voltage: 100-265V AC 50/60Hz  
 CRI: >80  
 Die casting Aluminum  
 Class: I  
 Color: Silver Grey/Dark Grey/Black/White



Dimension: 7W/133x133x90mm, 12W/160x160x120mm

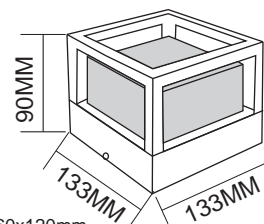

# 07

LED Indoor Step Light



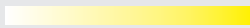

6000K 5000K 4000K 3000K 2700K



ST01-A

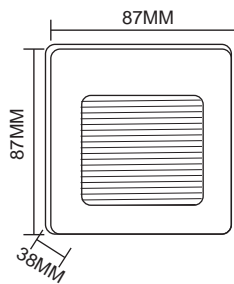

Name: Indoor LED 3W Step Light  
 Power: 3W  
 Input voltage: 100-265V AC 50/60Hz  
 CRI:>80  
 Aluminum  
 Color: Silver Grey/Dark Grey/Black/White



Dimension: 87x87x38mm  
 Cutout:73\*73\*H80mm



ST01-B

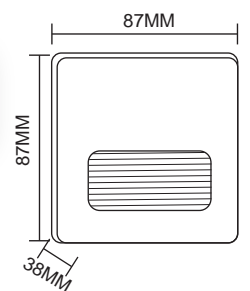

Name: Indoor LED 3W Step Light  
 Power: 3W  
 Input voltage: 100-265V AC 50/60Hz  
 CRI:>80  
 Aluminum  
 Color: Silver Grey/Dark Grey/Black/White



Dimension: 87x87x38mm  
 Cutout:73\*73\*H80mm



ST01-C

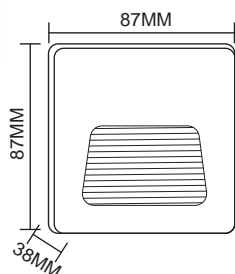

Name: Indoor LED 3W Step Light  
 Power: 3W  
 Input voltage: 100-265V AC 50/60Hz  
 CRI:>80  
 Aluminum  
 Color: Silver Grey/Dark Grey/Black/White



Dimension: 87x87x38mm  
 Cutout:73\*73\*H80mm



ST01-D

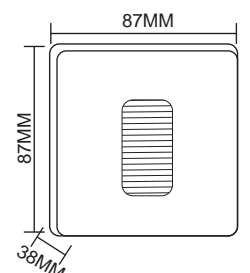
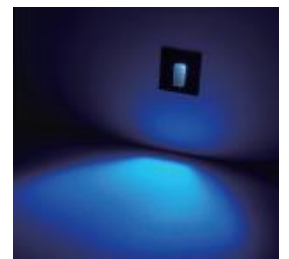
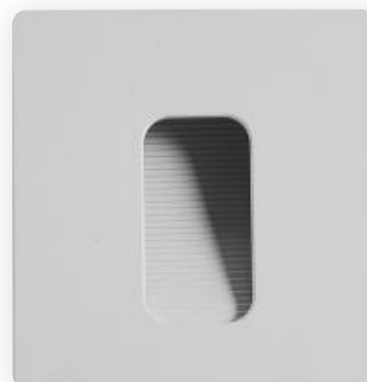

Name: Indoor LED 3W Step Light  
 Power: 3W  
 Input voltage: 100-265V AC 50/60Hz  
 CRI:>80  
 Aluminum  
 Color: Silver Grey/Dark Grey/Black/White



Dimension: 87x87x38mm  
 Cutout:73\*73\*H80mm



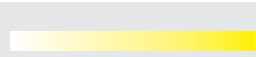

6000K 5000K 4000K 3000K 2700K



ST01-E

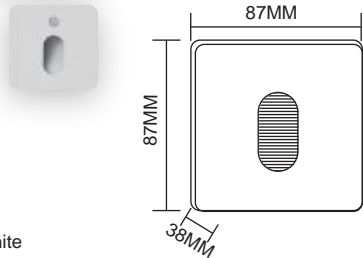
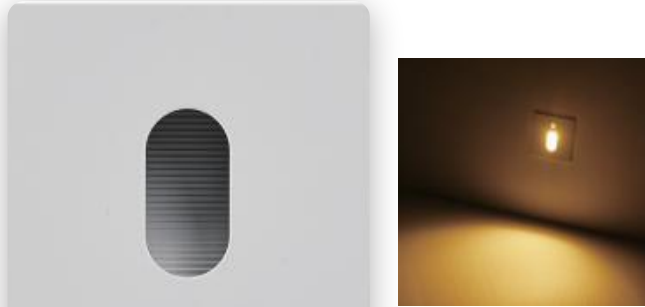

Name: Indoor LED 3W Step Light  
 Power: 3W  
 Input voltage: 100-265V AC 50/60Hz  
 CRI:>80  
 Aluminum  
 Color: Silver Grey/Dark Grey/Black/White



Dimension: 87x87x38mm  
 Cutout: 73\*73\*H80mm



ST01-F

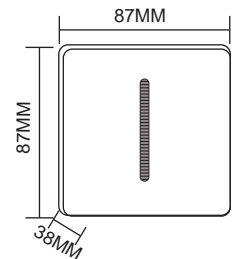
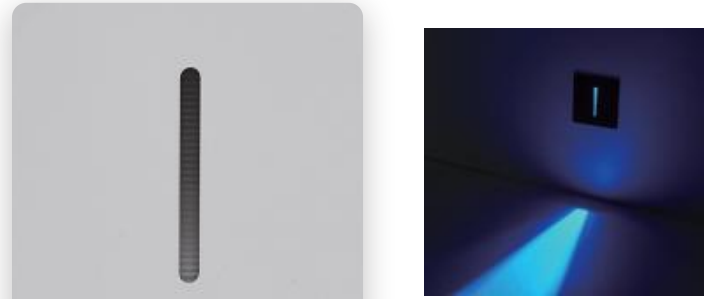

Name: Indoor LED 3W Step Light  
 Power: 3W  
 Input voltage: 100-265V AC 50/60Hz  
 CRI:>80  
 Aluminum  
 Color: Silver Grey/Dark Grey/Black/White



Dimension: 87x87x38mm  
 Cutout: 73\*73\*H80mm



ST01-FR

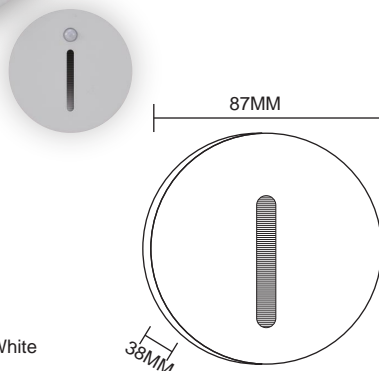

Name: Indoor LED 3W Step Light  
 Power: 3W  
 Input voltage: 100-265V AC 50/60Hz  
 CRI:>80  
 Aluminum  
 Color: Silver Grey/Dark Grey/Black/White



Dimension: Ø87x38mm  
 Cutout: Ø43x71x55mm



ST02-A

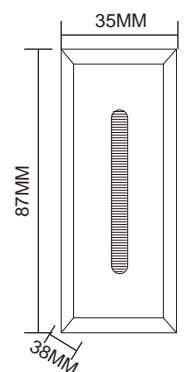
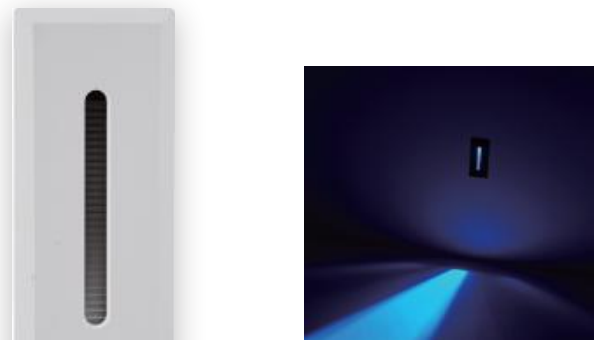

Name: Indoor LED 3W Step Light  
 Power: 3W  
 Input voltage: 100-265V AC 50/60Hz  
 CRI:>80  
 Aluminum  
 Color: Silver Grey/Dark Grey/Black/White



Dimension: 87x35x38mm  
 Cutout: 32x70x45mm



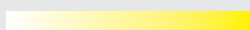

6000K 5000K 4000K 3000K 2700K



ST02-C

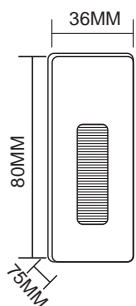
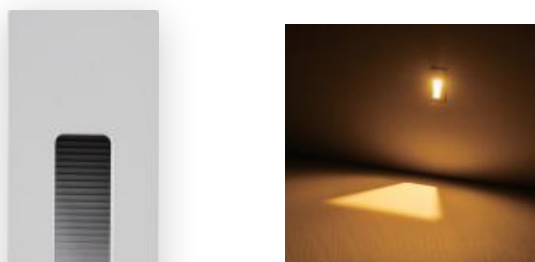

Name: Indoor LED 3W Step Light  
 Power: 3W  
 Input voltage: 100-265V AC 50/60Hz  
 CRI:>80  
 Aluminum  
 Color: Silver Grey/Dark Grey/Black/White



Dimension: 75x36x80mm  
 Cutout:32x70x45mm



ST02-D

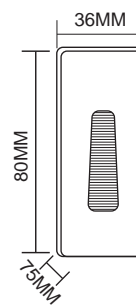

Name: Indoor LED 3W Step Light  
 Power: 3W  
 Input voltage: 100-265V AC 50/60Hz  
 CRI:>80  
 Aluminum  
 Color: Silver Grey/Dark Grey/Black/White



Dimension: 75x36x80mm  
 Cutout:32x70x45mm



ST03-A

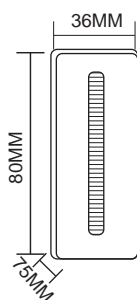
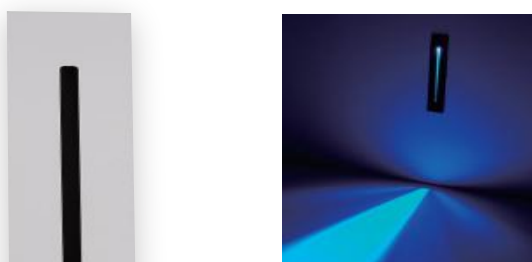

Name: Indoor LED 3W Step Light  
 Power: 3W  
 Input voltage: 100-265V AC 50/60Hz  
 CRI:>80  
 Aluminum  
 Color: Silver Grey/Dark Grey/Black/White



Dimension: 75x36x80mm  
 Cutout:32x70x45mm

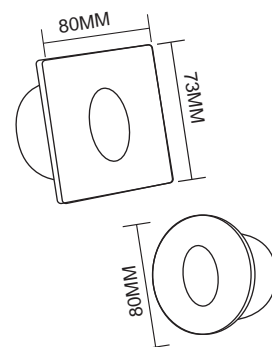

WL0803R, WL0803S Name:  
 Indoor LED 3W Step Light Power:  
 3W  
 Input voltage: 100-265V AC 50/60Hz  
 CRI:>80  
 Aluminum  
 Color: Silver Grey/Dark Grey/Black/White



Dimension: Ø80\*H73mm, 80\*80\*73mm  
 Cutout: Ø75mm



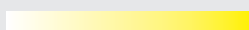

6000K 5000K 4000K 3000K 2700K



BS010R, BS010S  
 Name: Indoor LED 3W Step Light  
 Power: 3W  
 Input voltage: 100-265V AC 50/60Hz  
 CRI:>80  
 Aluminum  
 Color: Silver Grey/Dark Grey/Black/White



Dimension: Ø115mm, 115\*115mm  
 Cutout: Ø80x76mm, 80x80x76mm

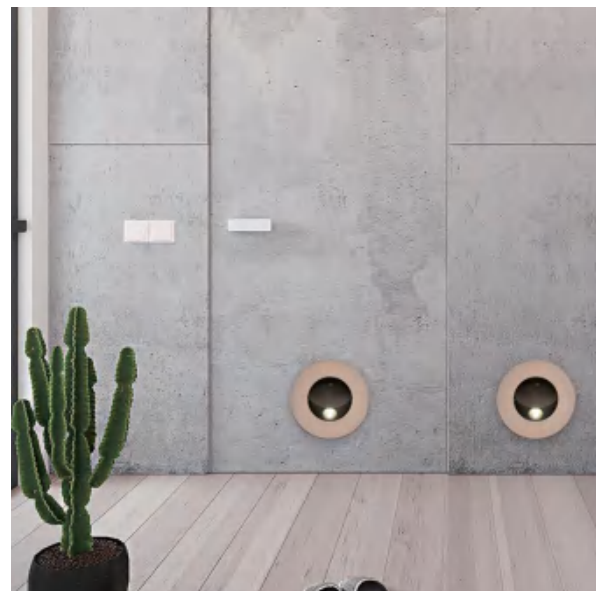
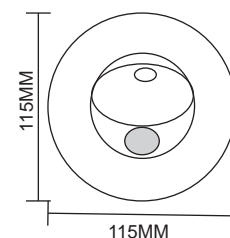
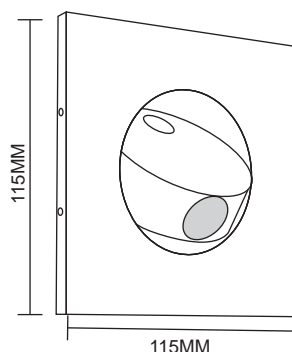

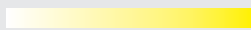

6000K 5000K 4000K 3000K 2700K

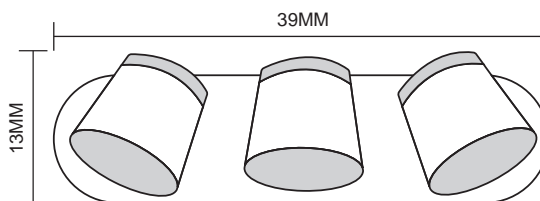
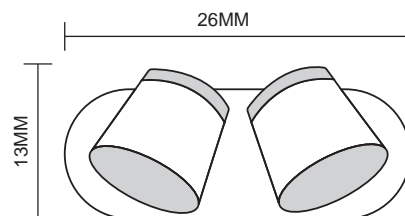
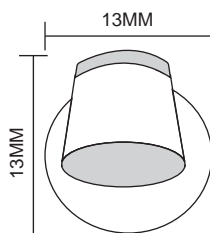

WL9801, WL9802, WL9803,  
 Name: Outdoor LED 5W/10W/15W Wall Light  
 Power: 5W/10W/15W  
 Input voltage: 100-265V AC 50/60Hz  
 CRI:>80  
 Die casting Aluminum  
 Class: I  
 Color: Silver Grey/Dark Grey/Black/White



Dimension: 5W/13mmx13mm  
 10W/26mmx13mm  
 15W/39mmx13mm



# THANK YOU

More products in [www.solucionled.com](http://www.solucionled.com)

Nelux HK international,Ltd., which is established in 2010 by European shareholders has been focusing on the researching, designing, molds and production of the top level commercial lighting products.  
Customised Lighting Products

Nelux (HK) international,ltd

**Address Head Office**

**18 harbour road, central plaza  
32/F 3208 office, wanchai, HK**

**Address Assembling Workshop**

**22 Kin Fat St. 11th Floor, Sun Hing Industrial Building,  
Tuen Mun, Hong Kong, China**