

Our OUTDOOR products are made from Solid passivated Anodized aluminum , aluminum and die-casting depending on references. and trim stainless steel.

Led Driver Khün, Xz, Osram, Philips.

Input Voltage Multivoltage and 220-240VAC/50-60Hz

INGROUND SERIES



IG6075 3W



IG6075-2 3W



IG6075-3 3W



IG6075-4 3W



IG7872 4W



IG4440 2W



IG4053 3W



IG4053S 3W



IG116T2 4W



IG11672-6 6W



IG11672-9 9W



IG13476 12W



IG200124 16W



IL6060 3W



IL6060 3W SIAIR INGROUND



IL6060 3W CEILING



COMMERCIAL AND RESIDENTIAL OUTDOOR, series Inground, reference IL6060B4 3W, high performance for your outdoor projects.



IG6075

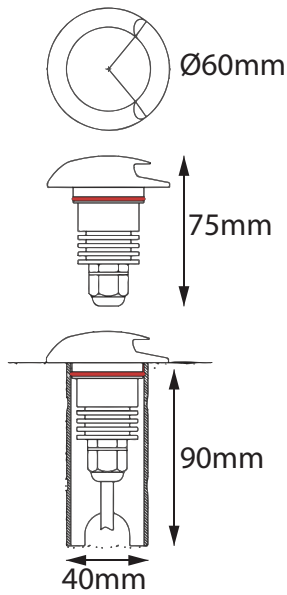

MAIN DATA

IP rating IP67
 IK rating IK10
 Housing material Solid Passivated (Anodizing) Aluminum
 CNC machined
 Protection finishing 11~13µm thickness anodized film for housing .Dark grey
 Trim Stainless steel 316
 Glass Tempered Glass T=4mm
 Loading capacity >2000 kgs
 Cable gland PG9 IP67
 Gasket O-ring PMQ silicone seal
 Accessories Passivated anodizing aluminum CNC machine

IG6075



GENERAL DATA

Power 3W
 Led type 1pc 3W CREE XPE led,
 Lumens ~100lm
 CCT 2700K, 3000K, 4000K, 6000K
 CRI >80
 Beam angle 1*100°
 Dimension Ø60*H75mm
 Cut out Ø40mm
 Net weight 0.370kg
 Warranty 3 years

ELECTRICAL DATA

Input voltage DC12V -DC24V
 Insulation class Class III
 Cable 1PC rubber cable 1.5M H05RN-F 2x0.75mm square
 Driver Low voltage constant current output excluding transformer



IG6075-2

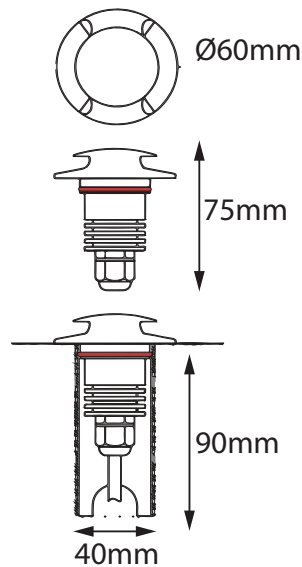

MAIN DATA

IP rating IP67
 IK rating IK10
 Housing material Solid Passivated (Anodizing) Aluminum
 CNC machined
 Protection finishing 11~13µm thickness anodized film for housing .Dark grey
 Trim Stainless steel 316
 Glass Tempered Glass T=4mm
 Loading capacity >2000 kgs
 Cable gland PG9 IP67
 Gasket O-ring PMQ silicone seal
 Accessories Passivated anodizing aluminum CNC machine

IG6075-2

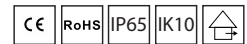

GENERAL DATA

Power 3W
 Led type 1pc 3W CREE XPE led,
 Lumens ~100lm
 CCT 2700K, 3000K, 4000K, 6000K
 CRI >80
 Beam angle 2*100°
 Dimension Ø60*H75mm
 Cut out Ø40mm
 Net weight 0.370kg
 Warranty 3 years

ELECTRICAL DATA

Input voltage DC12V -DC24V
 Insulation class Class III
 Cable 1PC rubber cable 1.5M H05RN-F 2x0.75mm square
 Driver Low voltage constant current output excluding transformer





IG6075-3

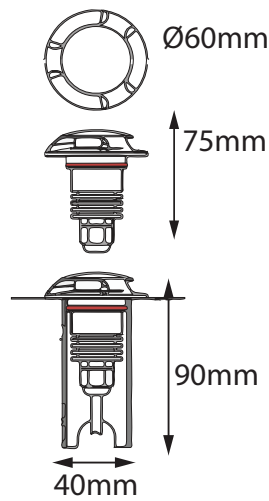

MAIN DATA

IP rating IP67
 IK rating IK10
 Housing material Solid Passivated (Anodizing) Aluminum
 CNC machined
 Protection finishing 11~13µm thickness anodized film for housing ,Dark grey
 Trim Stainless steel 316
 Glass Tempered Glass T=4mm
 Loading capacity >2000 kgs
 Cable gland PG9 IP67
 Gasket O-ring PMQ silicone seal
 Accessories Passivated anodizing aluminum CNC machine

IG6075-3

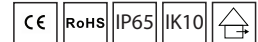

GENERAL DATA

Power 3W
 Led type 1pc 3W CREE XPE led,
 Lumens ~100lm
 CCT 2700K, 3000K, 4000K, 6000K
 CRI >80
 Beam angle 3°100°
 Dimension Ø60*H75mm
 Cut out Ø40mm
 Net weight 0.370kg
 Warranty 3 years

ELECTRICAL DATA

Input voltage DC12V -DC24V
 Insulation class Class III
 Cable 1PC rubber cable 1.5M H05RN-F 2x0.75mm square
 Driver Low voltage constant current output excluding transformer



IG6075-4

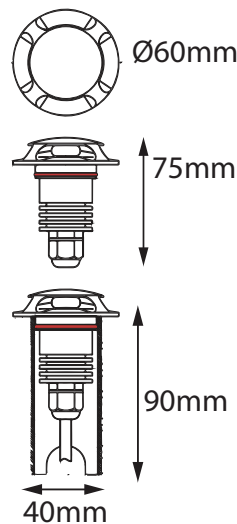

MAIN DATA

IP rating IP67
 IK rating IK10
 Housing material Solid Passivated (Anodizing) Aluminum
 CNC machined
 Protection finishing 11~13µm thickness anodized film for housing ,Dark grey
 Trim Stainless steel 316
 Glass Tempered Glass T=4mm
 Loading capacity >2000 kgs
 Cable gland PG9 IP67
 Gasket O-ring PMQ silicone seal
 Accessories Passivated anodizing aluminum CNC machine

IG6075-4



GENERAL DATA

Power 3W
 Led type 1pc 3W CREE XPE led,
 Lumens ~100lm
 CCT 2700K, 3000K, 4000K, 6000K
 CRI >80
 Beam angle 4°80°
 Dimension Ø60*H75mm
 Cut out Ø40mm
 Net weight 0.370kg
 Warranty 3 years

ELECTRICAL DATA

Input voltage DC12V -DC24V
 Insulation class Class III
 Cable 1PC rubber cable 1.5M H05RN-F 2x0.75mm square
 Driver Low voltage constant current output excluding transformer



IG7872

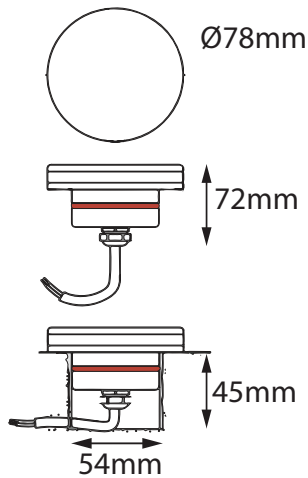

MAIN DATA

IP rating IP67
 IK rating IK10
 Housing material Solid Passivated (Anodizing) Aluminum
 CNC machined
 Protection finishing 20~25µm thickness anodized film for housing .Dark grey
 Trim Stainless steel 316
 Glass With out glass, but with PMMA diffuser
 Loading capacity >2000 kgs
 Cable gland PG7 IP67
 Gasket O-ring PMQ silicone seal
 Accessories Passivated anodizing aluminum CNC machine

IG7872



GENERAL DATA

Power 4W
 Led type 18pcs SMD2835
 Lumens ~150lm
 CCT 2700K, 3000K, 4000K, 6000K, R|G|Y|B
 CRI >80
 Beam angle 360°
 Dimension Ø78*H72mm
 Cut out Ø54mm
 Net weight 0.370kg
 Warranty 3 years

ELECTRICAL DATA

Input voltage DC24V
 Insulation class Class III
 Cable 1PC rubber cable 1.5M H05RN-F 2x0.75mm square
 Driver Low voltage constant current output excluding transformer



IG4440

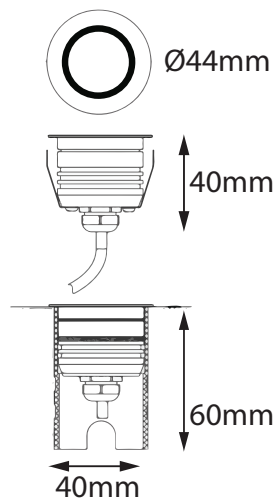

MAIN DATA

IP rating IP67
 IK rating IK07
 Housing material Solid Passivated (Anodizing) Aluminum
 CNC machined
 Protection finishing 20~25µm thickness anodized film for housing .Dark grey
 Trim Stainless steel 316
 Glass PMMA 5mm thickness
 Loading capacity 320 kgs
 Cable gland PG7 IP67
 Gasket O-ring PMQ silicone seal
 Accessories Passivated anodizing aluminum CNC machine

IG4440

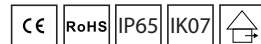

GENERAL DATA

Power 2W
 Led type 1pc CREE XPE
 Lumens ~120lm
 CCT 2700K, 3000K, 4000K, 6000K, R|G|Y|B
 CRI >80
 Beam angle 120°
 Dimension Ø44*H40mm
 Cut out Ø40mm
 Net weight 0.230kg
 Warranty 3 years

ELECTRICAL DATA

Input voltage DC12V/DC24V
 Insulation class Class III
 Cable 1PC rubber cable 1.5M H05RN-F 2x0.75mm square
 Driver Low voltage constant current output excluding transformer





IG4053

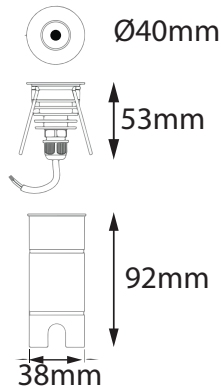

MAIN DATA

IP rating IP67
 IK rating IK06
 Housing material Solid Passivated (Anodizing) Aluminum
 CNC machined
 Protection finishing 11~13µm thickness anodized film for housing, Dark grey
 Trim Stainless steel 316
 Glass Step tempered Glass T=4mm
 Loading capacity 320 kgs
 Cable gland PG7 IP67
 Gasket O-ring PMQ silicone seal
 Accessories Passivated anodizing aluminum CNC machine

IG4053



GENERAL DATA

Power 3W
 Led type 1pc CREE XPE
 Lumens ~130lm
 CCT 2700K, 3000K, 4000K, 6000K, R|G|Y|B
 CRI >80
 Beam angle 15°, 25°, 38°, 45°, 60°, 120°
 Dimension Ø40*H53mm
 Cut out Ø38mm
 Net weight 0.210kg
 Warranty 3 years

ELECTRICAL DATA

Input voltage DC12V/DC24V
 Insulation class Class III
 Cable 1PC rubber cable 1.5M H05RN-F 2x0.75mm square
 Driver Low voltage constant current output excluding transformer



IG4053S

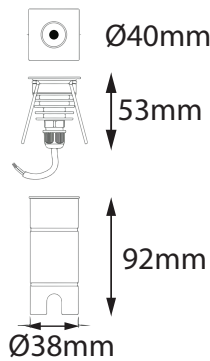

MAIN DATA

IP rating IP67
 IK rating IK06
 Housing material Solid Passivated (Anodizing) Aluminum
 CNC machined
 Protection finishing 11~13µm thickness anodized film for housing, Dark grey
 Trim Stainless steel 316
 Glass Step tempered Glass T=4mm
 Loading capacity 320 kgs
 Cable gland PG7 IP67
 Gasket O-ring PMQ silicone seal
 Accessories Passivated anodizing aluminum CNC machine

IG4053S



GENERAL DATA

Power 3W
 Led type 1pc CREE XPE
 Lumens ~130lm
 CCT 2700K, 3000K, 4000K, 6000K, R|G|Y|B
 CRI >80
 Beam angle 15°, 25°, 38°, 45°, 60°, 120°
 Dimension Ø40*H53mm
 Cut out Ø38mm
 Net weight 0.220kg
 Warranty 3 years

ELECTRICAL DATA

Input voltage DC12V/DC24V
 Insulation class Class III
 Cable 1PC rubber cable 1.5M H05RN-F 2x0.75mm square
 Driver Low voltage constant current output excluding transformer



IG11672

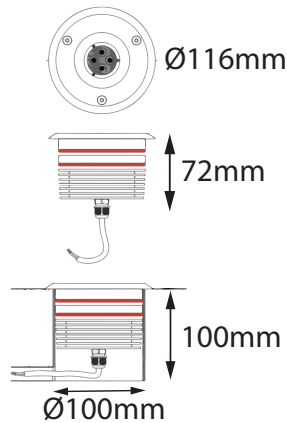

MAIN DATA

IP rating IP67
 IK rating IK09
 Housing material Solid Passivated (Anodizing) Aluminum
 CNC machined
 Protection finishing 20~25µm thickness anodized film for housing .Dark grey
 Trim Stainless steel 316
 Glass Step tempered Glass T=8mm
 Loading capacity 2000 kgs
 Cable gland PG7 IP67
 Gasket O-ring PMQ silicone seal
 Rotatable Manual rotating max 20°

IG11672



GENERAL DATA

Power 4W
 Led type 4pcs CREE XPE
 Lumens ~370lm
 CCT 2700K, 3000K, 4000K, 6000K, R|G|Y|B
 CRI >80
 Beam angle 20°, 40°, 60° (adjustable max 20°)
 Dimension Ø116*H72mm
 Cut out Ø100mm
 Net weight 1.220kg
 Warranty 3 years

ELECTRICAL DATA

Input voltage DC24V
 Insulation class Class III
 Cable 1PC rubber cable 1.5M H05RN-F 2x0.75mm square
 Driver Low voltage constant current output excluding transformer



IG11672-6

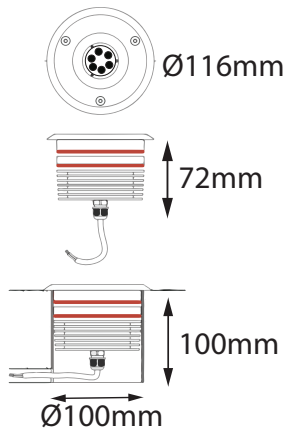

MAIN DATA

IP rating IP67
 IK rating IK09
 Housing material Solid Passivated (Anodizing) Aluminum
 CNC machined
 Protection finishing 20~25µm thickness anodized film for housing .Dark grey
 Trim Stainless steel 316
 Glass Step tempered Glass T=8mm
 Loading capacity 2000 kgs
 Cable gland PG7 IP67
 Gasket O-ring PMQ silicone seal
 Rotatable Manual rotating max 20°

IG11672-6



GENERAL DATA

Power 6W
 Led type 6pcs CREE XPE
 Lumens ~540lm
 CCT 2700K, 3000K, 4000K, 6000K, R|G|Y|B
 CRI >80
 Beam angle 20°, 40°, 60° (adjustable max 20°)
 Dimension Ø116*H72mm
 Cut out Ø100mm
 Net weight 1.253kg
 Warranty 3 years

ELECTRICAL DATA

Input voltage DC24V
 Insulation class Class III
 Cable 1PC rubber cable 1.5M H05RN-F 2x0.75mm square
 Driver Low voltage constant current output excluding transformer





IG11672-9

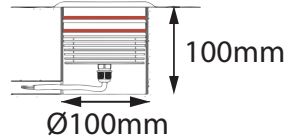
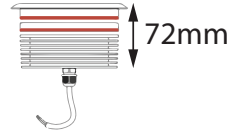
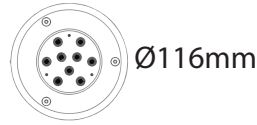

MAIN DATA

IP rating IP67
 IK rating IK09
 Housing material Solid Passivated (Anodizing) Aluminum
 CNC machined
 Protection finishing 20~25µm thickness anodized film for housing, Dark grey
 Trim Stainless steel 316
 Glass Step tempered Glass T=10mm
 Loading capacity 2000 kgs
 Cable gland PG7 IP67
 Gasket O-ring PMQ silicone seal
 Rotatable Manual rotating max 20°

IG11672-9

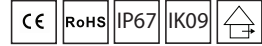

GENERAL DATA

Power 9W
 Led type 9pcs 1W CREE XPE
 Lumens ~810lm
 CCT 2700K, 3000K, 4000K, 6000K, R|G|Y|B
 CRI >80
 Beam angle 20°, 40°, 60° (adjustable max 20°)
 Dimension Ø134*H74mm
 Cut out Ø120mm
 Net weight 1.221kg
 Warranty 3 years

ELECTRICAL DATA

Input voltage DC24V
 Insulation class Class III
 Cable 1PC rubber cable 1.5M H05RN-F 2x0.75mm square
 Driver Low voltage constant current output excluding transformer



IG13476

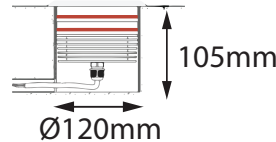
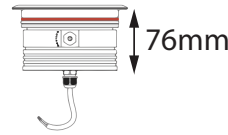

MAIN DATA

IP rating IP67
 IK rating IK09
 Housing material Solid Passivated (Anodizing) Aluminum
 CNC machined
 Protection finishing 20~25µm thickness anodized film for housing, Dark grey
 Trim Stainless steel 316
 Glass Step tempered Glass T=10mm
 Loading capacity 2000 kgs
 Cable gland PG7 IP67
 Gasket O-ring PMQ silicone seal
 Rotatable Manual rotating max 20°

IG13476

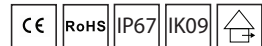

GENERAL DATA

Power 12W
 Led type 12pcs 1W CREE XPE
 Lumens ~1080lm
 CCT 2700K, 3000K, 4000K, 6000K, R|G|Y|B
 CRI >80
 Beam angle 20°, 40°, 60° (adjustable max 20°)
 Dimension Ø134*H76mm
 Cut out Ø120mm
 Net weight 1.243kg
 Warranty 3 years

ELECTRICAL DATA

Input voltage DC24V
 Insulation class Class III
 Cable 1PC rubber cable 1.5M H05RN-F 2x0.75mm square
 Driver Low voltage constant current output excluding transformer



IG200124

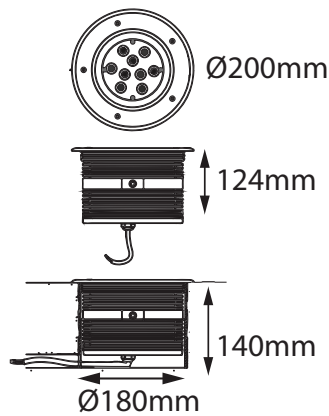

IG200124



GENERAL DATA

Power	16W
Led type	9pcs 2W CREE XPE
Lumens	~1350lm
CCT	2700K, 3000K, 4000K, 6000K, R G Y B
CRI	>80
Beam angle	8°, 10°, 17°, 23°, 28°, 43°, 58°, 95° (adjustable max 20°)
Dimension	Ø200*H124mm
Cut out	Ø178mm
Net weight	5.1kg

MAIN DATA

IP rating	IP67
IK rating	IK09
Housing material	Solid Passivated (Anodizing) Aluminum
	CNC machined
Protection finishing	20~25µm thickness anodized film for housing, Dark grey
Trim	Stainless steel 316
Glass	Step tempered Glass T=10mm
Loading capacity	2000 kgs
Cable gland	PG7 IP67
Gasket	O-ring PMQ silicone seal
Mounting sleeve	solid passivated anodizing aluminum CNC

ELECTRICAL DATA

Input voltage	DC24V
Insulation class	Class III
Cable	1PC rubber cable 1.5M H05RN-F 2x0.75mm square
Driver	Low voltage constant current output excluding transformer



COMMERCIAL AND RESIDENTIAL OUTDOOR, Inground Deco Series, reference IG200124, IP67 16W Anodizing aluminum.



COMMERCIAL & RESIDENTIAL OUTDOOR

nelux architectural lighting

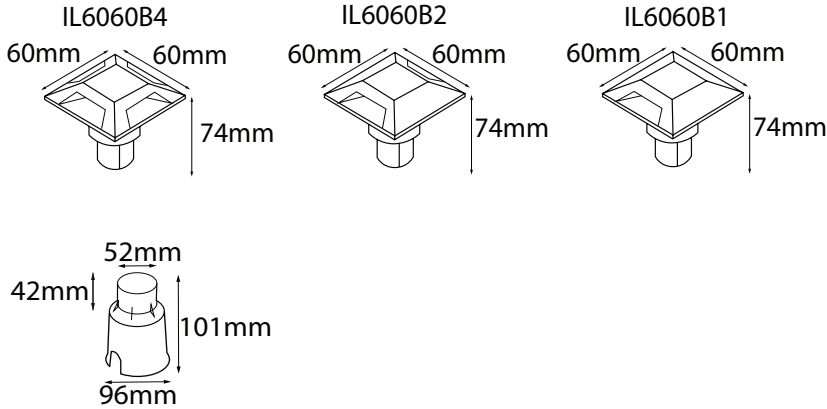
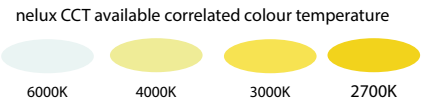
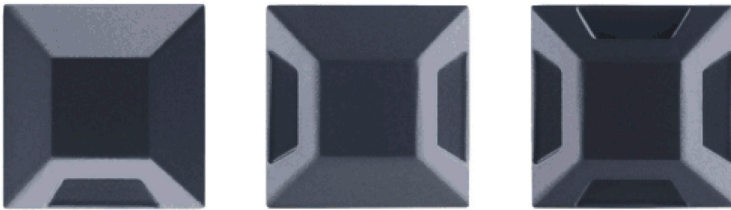

IL6060
 Material Aluminium anodized or powder painting
 Light Source cob CREE 3W
 CCT 2700K, 3000K, 4000K
 Input Voltage 110-240VAC
 IP54 fixture IK08
 Beam angle 20° (1Beam, 2Beam, 4 Beam angle)
 connector IP68 gel connector
 External driver constant current driver
 Cable H05RN-F 2x0.75mm² l=0.5m (low voltage)
 Mounting sleeve PC
 CRI>82

Splice connector



IP68 IK08

Outdoor In ground

Stairs In ground

Ceiling recessed

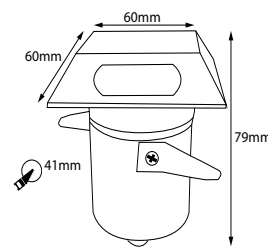
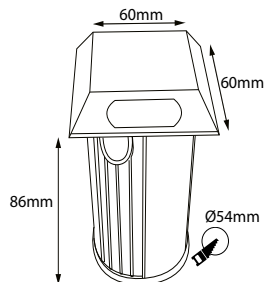
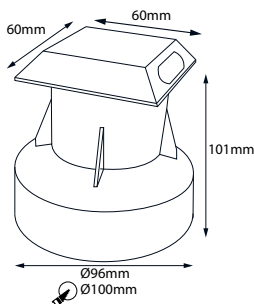

INGROUND DRIVE WAY

lighting product designers and mold management

